



Lake Company Catalog

"The Original Irrigation Manufacturer"



Introducing RAINITITE™
The New No-Leak Pipe
Product



sales@lakecompany.com
1-800-821-7273
www.lakecompany.com

3404 State Rd • Bakersfield, CA 93308



Lake Company

"The Original Irrigation Manufacturer"

The Original Irrigation Manufacturer and Wholesaler since 1977.



As a single source wholesale distributor for irrigation parts and systems, Lake Company provides high quality pumps, pipe, valves, fittings, and wheel moves to satisfy the needs of the irrigation industry. The following product lines are available for sale:

- Aluminum
- Pumps
- Sprinklers and Fittings
- Wheelmove Systems



RAINTITE™ Now Available!

RainTite is the leak-free aluminum pipe that will make your operation run smoother. The light weight design makes RainTite quick and easy to install and breakdown, saving you valuable time and money.

Pump Parts

We sell quality OEM-manufactured pump parts for all your pump equipment. Every part is ready to ship anywhere - domestic or international. Call us for a quote!

Pump Lines

PowerPrime™ and Premier Pump & Power manufacture pumps for all types of applications, from low volume to high flows. Request a quote or inquire about pricing.

Pump Partners



Ask about our Specialty Pumps!



We don't just SELL IT, we MAKE IT!

Quality Products. Made Right.

sales@lakecompany.com • 1-800-821-7273





Table of Contents

RainTite™ Pipe and Custom Fittings.....	2-3
Lateral Couplings (Latch) Aluminum.....	4-5
Lateral Couplings (No-Latch) Aluminum.....	6-7
Lateral Couplings (Dragline)Aluminum.....	8
Mainline (Latch) Aluminum.....	9-11
Valves (Latch) Aluminum.....	12-14
Mainline (Ringlock) Aluminum.....	15-16
Valves (Ringlock) Aluminum.....	17-19
Change-Overs Aluminum.....	20-22
Fabricated Fittings Aluminum.....	23-24
Lateral Couplings (Latch) Steel.....	25-26
Mainline (Latch) Steel.....	27-29
Valves (Latch) Steel.....	30
Mainline (Ringlock) Steel and Aluminum.....	31-34
Valves (Ringlock) Steel.....	35-37
Change-Overs (Steel).....	38-40
Fabricated Fittings Steel.....	41-42
Wheelmove Systems.....	43-48
Gated Pipe Accessories.....	49-52
Aluminum Pipe.....	53
Aluminum Pipe Specifications.....	54
Epoxy Saddles.....	55
Epoxy Fittings.....	56
Pumps, Specialty Pumps, and Pump Parts.....	57-59
Pump Accessories.....	60-65
Filtration Accessories.....	66
Industrial Fittings Aluminum.....	67
Industrial Fittings.....	68
Gaskets.....	69-70
Parts.....	71-72
Portable Aluminum Water Loading Stand.....	73
Hydrants.....	74
Flood Irrigation.....	75-76
Flow Meters.....	77-79
Gates.....	80
Sprinklers.....	81
Pressure Loss Through Water Meters.....	82
General Information.....	83
How to Identify Fittings & Gaskets.....	84



**ENGINEERED &
DESIGNED TO BE
LEAK-FREE**

**TESTED IN
THE FIELD FOR
INSTALLATION SPEED**

RAINTITE™ PIPE



**Pipe 3" X 30' RainTite™
PN# 1012471**

CUSTOM FITTINGS



**3" End Plug RainTite™
Standard WOH
PN# 1012951**



**3" End Plug
RainTite™ Custom
PN# 1012518**



**3" End Tee Aluminum
RainTite™ Custom
PN# 1012522**

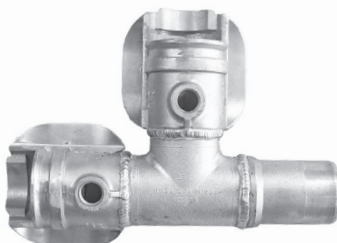

**3" Line Tee Right Aluminum
RainTite™ Custom
PN# 1012525**

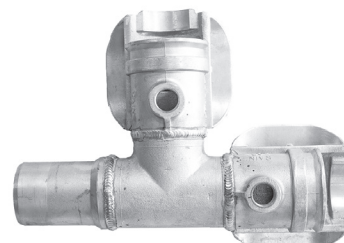

**3" Line Tee Left Aluminum
RainTite™ Custom
PN# 1012526**



CUSTOM FITTINGS



**4" X 3" X 3" Tee VL
Latch X RainTite™
Custom
PN# 1012763**

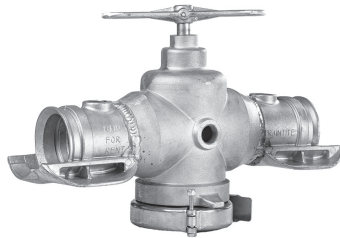

**4" X 3" X 3" Tee Valve
Ringlock X RainTite™
Custom
PN# 1012583**



**Valve 4" X 3" Main Ringlock X
Female National Pipe Thread
PN# 710109**

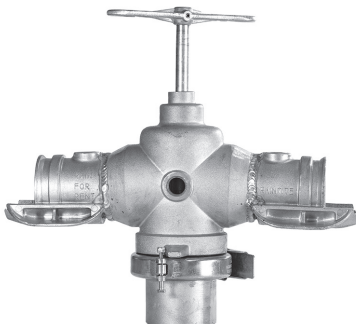

**4" X 3" X 3" Tee Valve
Ringlock X RainTite™ Custom
PN# 1012583 and PN# 710109**



**3" 90 Degree Elbow Right
Aluminum RainTite™
Custom
PN# 1012521**

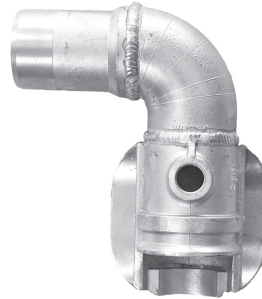

**3" 90 Degree Elbow Left
Aluminum RainTite™
Custom
PN# 1012520**



**3" Band & Latch
RainTite™ Custom
PN# 1012633**



**3" Band & Latch
RainTite™ Custom
PN# 1012633**

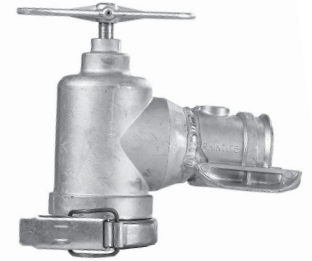

**4" X 3" Elbow Ringback
RainTite™ Custom
PN# 1012643**

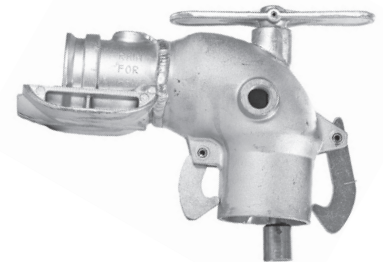

**4" X 3" Elbow Valve Latch
X RainTite™ Custom
PN# 1012519**



**4" X 3" Elbow Ringlock X
Raintite Custom
PN# 1012643**

**The Original
Irrigation
Manufacturer
and Wholesaler
since 1977.**



LATERAL COUPLINGS LATCH, ALUMINUM

COUPLER WITH 3/4" STEEL RISER OUTLET



WL

Lake/Univ. Crown	Roundback	PN#	Description	Weight
		710012	2"	1.14 lbs.
		713013	3" w/gasket	1.56 lbs.
		710014	4"	2.00 lbs.

WL Lateral Coupler Aluminum
With 3/4" Steel Riser Outlet

WELD-ON LATCH PAD

(Includes Latch, Spring and Pin)



WLP

Lake/Univ. Crown	Roundback	PN#	Description	Weight
		710103	3"	.50 lbs.
		710104	4"	.50 lbs.

WLP Weld-on Latch Pad Aluminum

BAND & LATCH

(Includes Band, Latch, Bolt, Nut and Spring)



BL

Lake/Univ. Crown	Roundback	PN#	Description	Weight
		710112	2"	.60 lbs.
		710113	3"	.70 lbs.
		710114	4"	.79 lbs.

BL Band with Latch Aluminum

END PLUG

(Includes Latch, Pin and Spring)



EP

Lake/Univ. Crown	Roundback	PN#	Description	Weight
		710172	2"	.80 lbs.
		710173	3"	1.20 lbs.
		710174	4"	1.69 lbs.

EP End Plug Latch Aluminum



LATERAL COUPLINGS LATCH, ALUMINUM

90 DEGREE ELBOW



MFL

Lake/Univ. Crown	Roundback	PN#	Description	Weight
		710192	2"	2.20 lbs.
		710193	3"	3.44 lbs.
		710194	4"	4.13 lbs.

MFL 90 Degree Elbow M x F Latch Aluminum

LINE TEE

(Includes Latch, Spring and Pin)



LT

Lake/Univ. Crown	Roundback	PN#	Description	Weight
		710222	2"	3.03 lbs.
		710223	3"	4.78 lbs.
		710224	4"	6.59 lbs.

LT Line Tee Latch Aluminum

END TEE



ET

Lake/Univ. Crown	Roundback	PN#	Description	Weight
		710232	2"	3.03 bs.
		710233	3"	4.780 lbs.
		710234	4"	6.73 lbs.

ET End Tee Latch Aluminum

REDUCER BUSHING



RB

Lake/Univ. Crown	Roundback	PN#	Description	Weight
		710283	3x2	.60 lbs.
		710284	4x3	.43 lbs.
		710285	5x4	.75 lbs.

RB Reducer Bushing Aluminum



LATERAL COUPLINGS NO LATCH, ALUMINUM

NO-LATCH COUPLER



NL

Lake/Univ. Crown	Roundback	PN#	Description	Weight
		712033	3" w/gasket	1.49 lbs.
		710034	4"	1.73 lbs.

NL No Latch Coupling

NO-LATCH BAND



NLB

Lake/Univ. Crown	Roundback	PN#	Description	Weight
		710133	3"	.19 lbs.
		710134	4"	.22 lbs.

NLB No Latch Band

NO-LATCH END PLUG



NEP

Lake/Univ. Crown	Roundback	PN#	Description	Weight
		710182	2"	.440 lbs.
		712779	3" DRAG/NEP END PLUG	.685 lbs.
			one plug for both couplers	
		710184	4"	1.16 lbs.

NEP No Latch End Plug



LATERAL COUPLINGS NO LATCH, ALUMINUM

NO-LATCH 90 DEGREE ELBOW



NMFL

Lake/Univ.	Crown	Roundback	PN#	Description	Weight
			710202	2"	1.68 lbs.
			710203	3"	3.10 lbs.
			710204	4"	4.13 lbs.

NMFL No Latch 90 Degree Elbow

NO-LATCH LINE TEE



NLT

Lake/Univ.	Crown	Roundback	PN#	Description	Weight
			710242	2"	2.51 lbs.
			710243	3"	4.41 lbs.
			710244	4"	6.27 lbs.

NLT No Latch Line Tee

NO-LATCH END TEE



NET

Lake/Univ.	Crown	Roundback	PN#	Description	Weight
			710252	2"	2.51 lbs.
			710253	3"	4.41 lbs.
			710254	4"	6.27 lbs.

NET No Latch End Tee

NO-LATCH ADAPTER

(Includes Latch,
Spring, Nut and Bolt)



NLA

Lake/Univ.	Crown	Roundback	PN#	Description	Weight
			710302	2"	.76 lbs.
			710303	3"	1.00 lbs.
			710304	4"	1.03 lbs.

NLA No Latch Adapter (Associated)

2" - 700302, 710481, 710484, 710485, 710490
 3" - 700303, 710481, 710484, 710485, 710490
 4" - 700304, 710481, 710484, 710485, 710490



LATERAL COUPLINGS DRAGLINE, ALUMINUM

DRAGLINE COUPLER



DLC

Lake/Univ. Crown	Roundback	PN#	Description	Weight
		710127	3 DBL Dragline Half Band	.19 lbs.
		713411	3" w/gasket Female End Plug	4.75 lbs.
		712125	3" w/gasket	2.35 lbs.
		712125	3" w/gasket	2.35 lbs.

DLC Dragline Coupler Aluminum
(Associated) 710413, 712411

DRAGLINE STEEL PULLER



DLCP

Lake/Univ. Crown	Roundback	PN#	Description	Weight
		710118	3"	4.69 lbs.

DLCP Dragline Puller Steel

DRAGLINE PULLING ADAPTER



DLCA

Lake/Univ. Crown	Roundback	PN#	Description	Weight
		710117	3"	4.75 lbs.

DLC x DLC Dragline DBL Female Adapter Aluminum

CENTER RISER ASSEMBLY



CRB

Foot (A)

Lake/Univ. Crown	Roundback	PN#	Description	Weight
		710021	3" Without Foot (A)	2.30 lbs

CRB Center Riser Assembly Bolt On (Associated)
3" - 710020, 710484, 711789, 711960, 711961, 717137

CENTER RISER GASKET (For use with above)



CRG

Lake/Univ. Crown	Roundback	PN#	Description	Weight
		710020		.010 lbs.

CRG Center Riser Gasket



FEMALE COUPLER



WM

Lake/Univ.	Crown	Roundback	PN#	Description	Weight
			710054	4"	1.19 lbs.
			710055	5"	1.51 lbs.
			710056	6"	1.68 lbs.
			710058	8"	3.50 lbs.
			710059	10"	4.16 lbs.

WM Weld-on Female Mainline Latch Coupler Aluminum

MALE COUPLER



HDE

Lake/Univ.	Crown	Roundback	PN#	Description	Weight
			710990	4" HE	1.45 lbs.
			710168	8"	5.05 lbs.
			710169	10"	5.71 lbs.

HDE Male Coupler with Latches Aluminum

BAND & LATCH

(Includes Band, Latch, Bolt, Nut & Springs)



BL

Lake/Univ.	Crown	Roundback	PN#	Description	Weight
			710114	4"	.79 lbs.
			710115	5"	1.85 lbs.
			710116	6"	13.45 lbs.

BL Band with Latch Aluminum

HEAVY BAND & LATCH

(Includes Band, Latch, Bolt, Nut & Springs)



HBL

Lake/Univ.	Crown	Roundback	PN#	Description	Weight
			710158	8"	2.25 lbs.

HBL Heavy Band with Latch Aluminum



WELD-ON LATCH PAD

(Includes Latch, Spring & Pin)



WLP

Lake/Univ. Crown	Roundback	PN#	Description	Weight
		710106	6"	.90 lbs.

WLP Weld-on Latch Pad Aluminum

END PLUG

(Includes Latch)



EP

Lake/Univ. Crown	Roundback	PN#	Description	Weight
		710175	5"	1.89 lbs.
		710176	6"	3.09 lbs.

EP End Plug Latch Aluminum

HEAVY END PLUG

(Includes Latch)



HEP

Lake/Univ. Crown	Roundback	PN#	Description	Weight
		710178	8"	7.20 lbs.
		710179	10"	9.06 lbs.

HEP Heavy End Plug Latch Aluminum



MAINLINE LATCH, ALUMINUM

90 DEGREE ELBOW



MFL

Lake/Univ. Crown	Roundback	PN#	Description	Weight
		710195	5"	6.75 lbs.
		710196	6"	8.29 lbs.
		710198	8"	12.90 lbs.
		710199	10"	16.91 lbs.

MFL M x F 90 Degree Elbow Latch Aluminum
Also Available in 45 Degree Elbow

LINE TEE



LT

Lake/Univ. Crown	Roundback	PN#	Description	Weight
		710225	5"	7.64 lbs.
		710226	6"	9.32 lbs.
		710228	8"	17.84 lbs.
		710229	10"	24.07 lbs.

LT Line Tee Latch Aluminum

END TEE



ET

Lake/Univ. Crown	Roundback	PN#	Description	Weight
		710235	5"	7.50 lbs.
		710236	6"	9.19 lbs.
		710238	8"	17.84 lbs.
		710239	10"	24.07 lbs.

ET End Tee Latch Aluminum



VALVES LATCH, ALUMINUM

WELD-ON VALVE

(With 4" Outlet)



WV

Lake/Univ. Crown	Roundback	PN#	Description	Weight
		710064	4"	7.21 lbs.
		710065	5"	8.30 lbs.
		710066	6"	9.20 lbs.
		710068	8"	11.69 lbs.

WV Weld on Valve Latch Aluminum

MALE-FEMALE VALVE

(With 4" Outlet)



MFV

Lake/Univ. Crown	Roundback	PN#	Description	Weight
		710089	4"	10.00 lbs.
		710090	5"	10.50 lbs.
		710091	6"	11.90 lbs.
		710092	8"	16.90 lbs.
		710093	10"	---

MFV Male - Female Valve Latch Aluminum

MAINLINE VALVE

(With 4" Outlet)



MV

Lake/Univ. Crown	Roundback	PN#	Description	Weight
		710084	4"	8.50 lbs.
		710085	5"	10.00 lbs.
		710086	6"	11.50 lbs.
		710088	8"	19.70 lbs.

MV Mainline Valve Latch Aluminum



VALVES LATCH, ALUMINUM

WELD-ON SADDLE VALVE (With 4" Outlet)

WSV



Lake/Univ. Crown	Roundback	PN#	Description	Weight
		710079	4"	5.21 lbs.

WSV Saddle Valve Weld-on

- For use with Lake VL and VT
- Note OD pipe size when ordering

STATIONARY VALVE

With 4" Outlet
& 4" Female
Thread Std.

SV



Lake/Univ. Crown	Roundback	PN#	Description	Weight
		710094	4x4	7.40 lbs.

SV Stationary Valve Aluminum

- For use with Lake VL and VT

VALVE OPENING ELBOW

4" Inlet Only
3/4" Riser Outlet

VL



Lake/Univ. Crown	Roundback	PN#	Description	Weight
		710263	3"	5.70 lbs.
		710264	4"	5.54 lbs.

VL Valve Opening Elbow Latch Aluminum

- For use with WV, MFV, MV, WSV, SV

VALVE OPENING TEE

4" Inlet Only
3/4" Riser Outlet

VT



Lake/Univ. Crown	Roundback	PN#	Description	Weight
		710273	3"	6.34 lbs.
		710274	4"	6.56 lbs.

VT Valve Opening Tee Latch Aluminum

- For use with WV, MFV, MV, WSV, SV



MAINLINE VALVE PARTS

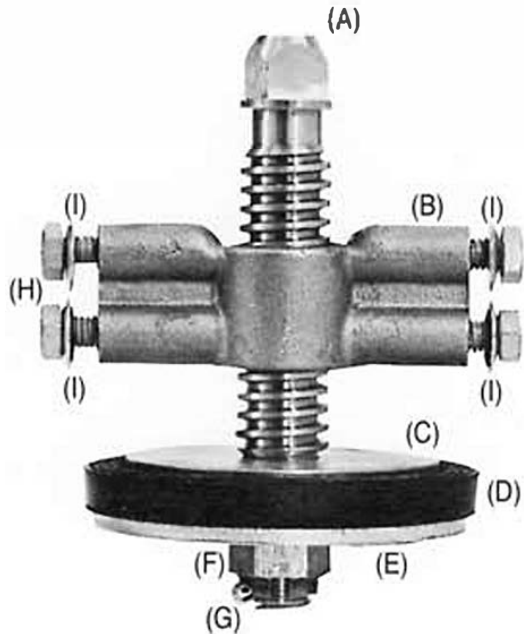

Lake/Univ. Crown Roundback PN# Description

A	710460	ML Valve Screw Brass
B	710461	ML Valve Wing Nut Brass (old style)
C	710462	ML 3 1/4" Valve Washer Top
D	710463	ML 4" Valve Disc. (Used in 4 WV, WSV & SV)
E	710464	ML 5" Valve Disc. (Used in 5,6, & 8 WV)
F	710465	ML 3 7/8" Bottom Washer disc
G	710466	ML 5/8" Nut Castillated
H	710467	ML Cotter Key Brass
I	710468	ML 3/8 x 1" Hex Bolt NC Plated (old style)
J	710469	ML Wing Nut Washer (old style)

Mainline Latch Valve Parts Aluminum

- For use on: WV, WSV, SV
- 6" OD style
- Used on bottom opener valves

LATCH VALVE OPENER PARTS FOR VL & VT

Lake/Univ. Crown Roundback PN# Description

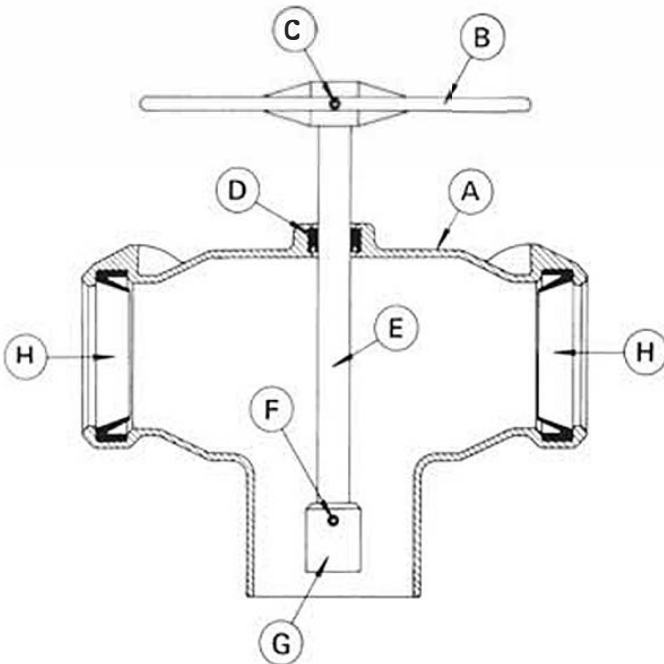

700263	3"x4" VL Casting
700264	4"x4" VL Casting
710471	(B) Valve Opening Handle
710472	(C) 1/4" x 1 5/8" Roll Pin
710411	(D) Chevron Gasket 3/4" Single
710470	(E) Valve Opener Stem
710475	(F) Connector Pin 1/4" x 1 1/4" Type 5-303 GRV
710474	(G) Valve Opener Connecting Joint
710413	(H) 3" NDG Gasket, Fits Aluminum
710414	(H) 4" NDG Gasket, Fits Aluminum
710476	(I) Short Valve Opener Latch (Used on VL)
710490	(J) 1/4" Latch Steel, (2 Used on VT)

* Not pictured

Valve Opener Parts Latch Style



RINGLOCK ASSEMBLY

(Includes Male End, Female End, Clamp & Gasket)



RLA

Lake/Univ. Crown	Roundback	PN#	Description	Weight
		710185	6"	5.43 lbs.
		710186	8"	7.08 lbs.
		710187	10"	10.83 lbs.

RLA Ringlock Assembly Aluminum (Associated)

6" - 710051, 710157, 710161, 710416

8" - 710052, 710159, 710162, 710418

10" - 710053, 710160, 710163, 710419

RINGLOCK FEMALE COUPLER

(Includes Gasket)



RWM

Lake/Univ. Crown	Roundback	PN#	Description	Weight
		710157	6"	1.43 lbs.
		710159	8"	2.15 lbs.
		710160	10"	3.56 lbs.

RWM Coupler Ringlock Female x Weld-on Aluminum

RINGLOCK MALE COUPLER



RHE

Lake/Univ. Crown	Roundback	PN#	Description	Weight
		710161	6"	1.34 lbs.
		710162	8"	1.75 lbs.
		710163	10"	3.25 lbs.

RHE Coupler Ringlock Male x Weld-on Aluminum

RINGLOCK CLAMP



RC

Lake/Univ. Crown	Roundback	PN#	Description	Weight
		710051	6"	2.18 lbs.
		710052	8"	2.70 lbs.
		710053	10"	3.25 lbs.

RC Ringlock Clamp Aluminum (Gold Color)
For Aluminum RL Couplers Only



RINGLOCK END PLUG



REP

Lake/Univ.	Crown	Roundback	PN#	Description	Weight
			710170	6"	2.25 lbs.
			710171	8"	4.00 lbs.
			710180	10"	6.50 lbs.

REP Ringlock End Plug Aluminum

RINGLOCK 90 DEGREE ELBOW



RMFL

Lake/Univ.	Crown	Roundback	PN#	Description	Weight
			710189	6"	5.70 lbs.
			710190	8"	9.00 lbs.
			710191	10"	14.00 lbs.

RMFL 90 Degree Elbow Ringlock M x F Aluminum

Also available in 45°, 22-1/2°

RINGLOCK LINE TEE



RLT

Lake/Univ.	Crown	Roundback	PN#	Description	Weight
			710220	6"	7.50 lbs.
			710221	8"	14.00 lbs.
			710230	10"	20.43 lbs.

RLT Ringlock Line Tee Aluminum

RINGLOCK END TEE



RET

Lake/Univ.	Crown	Roundback	PN#	Description	Weight
			710231	6"	8.19 lbs.
			710240	8"	14.00 lbs.
			710241	10"	21.30 lbs.

RET Ringlock End Tee Aluminum



VALVES RINGLOCK, ALUMINUM

RINGLOCK WELD-ON VALVE



RWV

Lake/Univ. Crown	Roundback	PN#	Description	Weight
		710164	6"	5.10 lbs.
		710165	8"	6.10 lbs.
		710166	10"	8.70 lbs.

RWV Ringlock Valve Weld-on Aluminum

		710080	6"x4"	lbs.
		710081	8"x4"	lbs.
		710082	10"x4"	lbs.

RMFV Ringlock Male x Female Valve

RINGLOCK VALVE OPENING ELBOW

(4" I.D. Inlet Only)



RVL

Lake/Univ. Crown	Roundback	PN#	Description	Weight
		710267	3"	6.96 lbs.
		710268	4"	7.02 lbs.

RVL Ringlock Valve Opening Elbow Aluminum

- With a 3/4" outlet, clamp included

RINGLOCK VALVE OPENING TEE



RVT

Lake/Univ. Crown	Roundback	PN#	Description	Weight
		710275	3"	7.97 lbs.
		710276	4"	8.25 lbs.

RVT Ringlock Valve Opening Tee Aluminum

- With a 3/4" outlet, clamp included



VALVES RINGLOCK, ALUMINUM

RINGLOCK STUB VALVE



RSV

Lake/Univ. Crown	Roundback	PN#	Description	Weight
		710095	4"	2.74 lbs.

RSV Ringlock Stub Valve Aluminum

		711293	6"x4"	
		711291	4"x8"	
		711291	4"x10"	1.80 lbs.
		711292	4"x12"	

RSV Ringlock Stub Valve Aluminum with Saddle

WELD-ON PIPE SADDLE (Fits 4" I.D. Inlet Only)



PS

Lake/Univ. Crown	Roundback	PN#	Description	Weight
		710096	6"	.25 lbs.
		710097	8"	.25 lbs.
		710098	10"	.25 lbs.
		710099	12"	.39 lbs.

PS Weld-on Saddle

4" RSVF THREADED VALVE



(4" RSVF x 4" Female NPT Thread)



RSVF

Lake/Univ. Crown	Roundback	PN#	Description	Weight
		710109	4" x 3"	2.10 lbs.
		710110	4" x 4"	3.30 lbs.

RSVF Threaded Female Valve Aluminum

4" RSVM THREADED VALVE



(4" RSVM x 4" Male NPT Thread)



RSVM

Lake/Univ. Crown	Roundback	PN#	Description	Weight
		710111	4" x 4"	3.00 lbs.

RSVM Threaded Male Valve Aluminum

RWSV

Lake/Univ. Crown	Roundback	PN#	Description	Weight
		711293	4" x 6"	0.00 lbs.
		711294	4" x 8"	0.00 lbs.
		711291	4" x 10"	1.80 lbs.
		711292	4" x 12"	1.80 lbs.



VALVES RINGLOCK, ALUMINUM

RINGLOCK VALVE PARTS

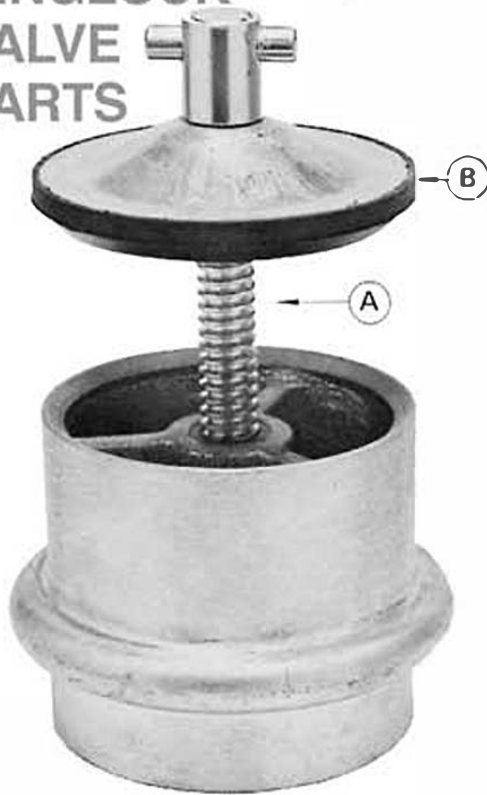

Lake/Univ. Crown Roundback PN# Description

- 710494 (A) Ringlock Valve Screw Brass (5/8" 7 Thread Acme)
- 710496 (B) Ringlock Valve Disc. 4 (Original Universal)

For use with: RWV, RSV, RWSV, RSVF, RSVM, RLMFV

Ringlock Valve Parts

RINGLOCK VALVE OPENER PARTS

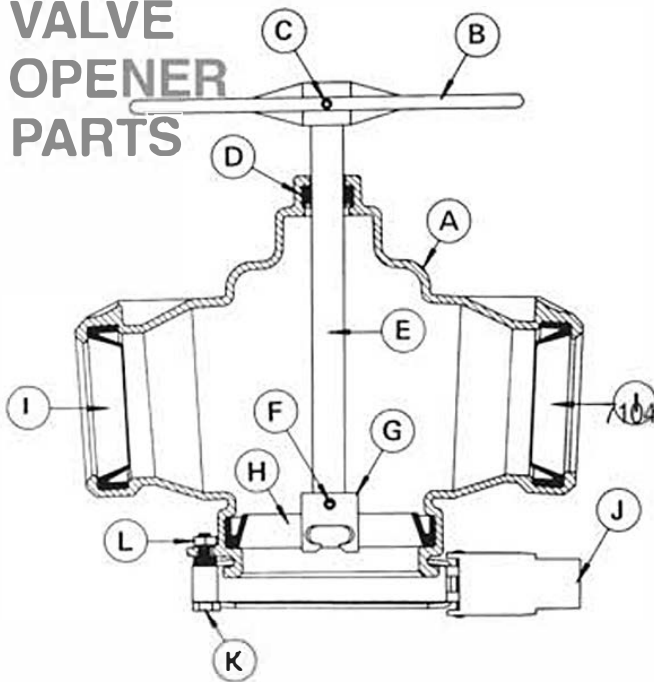

Lake/Univ. Crown Roundback PN# Description Weight

- 700267 4"x 3" RVL Casting 3.20 lbs.
- 700276 4"x 4" RVL Casting 4.41 lbs.
- 700268 4"x 4" RVL Casting 3.38 lbs.
- 700275 3"x 4" RVT Casting 4.00 lbs.
- 700267 4"x 3" RVL Casting 3.20 lbs.
- 700276 4"x 4" RVT Casting 4.41 lbs.
- 710471 (B) Valve Opening Handle (Alumn.) .35 lbs.
- 710472 (C) 1/4" x 1 5/8" Roll Pin
- 710411 (D) 3/4" Chevron Gasket Single
- 710470 (E) Valve Opener Stem
- 710475 (F) Connector Pin 1/4" x 1 1/4" Type 303
- 710495 (G) Ringlock Valve Opener Clutch
- 710414 (H) 4" NDG Gasket fits Alum. Inlet .12 lbs.
- 710040 (J) RL Valve Opener Clamp 1/2" with hook
- 710413 (I) 3" NDG Gasket fits Alum. 3" OL .09 lbs.
- 710041 RL Valve Opener Clamp 1/2" with handle
- 711588 1/4 x 2 1/4" HEX Bolt NC Plated
- 710510 (K) 1/4" HEX Locknut NC Plated

Ringlock Valve Opener Parts

For use with: RVL, RVT



CHANGE-OVERS ALUMINUM

CHANGE-OVER MALE

Male Thread x Tubing O.D. WFE



AML

Lake/Univ. Crown	Roundback	PN#	Description	Weight
		710312	2"	1.40 lbs.
		710313	3"	2.00 lbs.
		710314	4"	2.70 lbs.
		710315	5"	3.20 lbs.
		710316	6"	5.00 lbs.
		710318	8"	6.40 lbs.

AML Adapter Male Latch x MIPT Aluminum

CHANGE-OVER FEMALE

Male Thread x WM Coupling



AFL

Lake/Univ. Crown	Roundback	PN#	Description	Weight
		710322	2"	1.00 lbs.
		710323	3"	1.70 lbs.
		710324	4"	2.70 lbs.
		710325	5"	3.40 lbs.
		710326	6"	4.20 lbs.
		710328	8"	6.30 lbs.

AFL Adapter Female Latch x MIPT Aluminum

MALE BY FEMALE ADAPTER

Male O.D. x WM Coupling

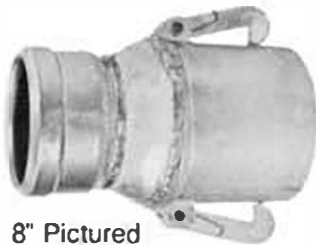

8" Pictured

AMF

Lake/Univ. Crown	Roundback	PN#	Description	Weight
		710332	3" x 2"	3.30 lbs.
		710333	4" x 3"	4.40 lbs.
		710334	6" x 4"	6.80 lbs.
		710335	6" x 5"	7.00 lbs.
		710336	8" x 6"	7.90 lbs.
		710337	10" x 8"	9.40 lbs.
		710338	8"	8.30 lbs.
		710339	10"	10.50 lbs.

AMF Adapter M x F Latch Aluminum

2" - 6" Single Latch 8" - 10" Double Latch

FEMALE REDUCER

Female x Female Coupler



RFF

Lake/Univ. Crown	Roundback	PN#	Description	Weight
		710342	3" x 2"	3.10 lbs.
		710343	4" x 3"	3.30 lbs.
		710344	5" x 4"	3.70 lbs.
		710345	6" x 4"	4.00 lbs.
		710346	6" x 5"	4.40 lbs.
		710348	8" x 6"	—
		710349	10" x 8"	—

RFF Reducer F x F Latch Aluminum



CHANGE-OVERS ALUMINUM

CHANGE-OVER

Ringlock by Latch type



ARL

Lake/Univ.	Crown	Roundback	PN#	Description	Weight
			710277	6"	3.20 lbs.
			710278	8"	5.20 lbs.
			710279	10"	7.90 lbs.

ARL Adapter Female Ringlock x Male Latch Aluminum

MAINLINE COUPLER

Female Coupler x Female Coupler



MC

Lake/Univ.	Crown	Roundback	PN#	Description	Weight
			710985	5"	2.98 lbs.
			710986	6"	3.29 lbs.
			710988	8"	7.40 lbs.
			710989	10"	9.50 lbs.

MC Coupler Female x Female Latch Aluminum



CHANGE-OVERS ALUMINUM

CHANGE-OVER MALE

MIPT Thread x Male Ringlock Coupler (RHE)



AMR

Lake/Univ. Crown	Roundback	PN#	Description	Weight
		710295	6"	3.700 lbs.
		710296	8"	5.300 lbs.
		710297	10" x 8"	6.200 lbs.

AMR Adapter Male RL x MIPT Aluminum

CHANGE-OVER FEMALE

Male Thread x Ringlock Female Coupler (RWM)



AFR

Lake/Univ. Crown	Roundback	PN#	Description	Weight
		710320	6"	3.90 lbs.
		710321	8"	5.30 lbs.
		710330	10" x 8"	6.90 lbs.

AFR Adapter Female RL x MIPT Aluminum

MALE BY FEMALE ADAPTER

Ringlock Male x Female Coupler (RHE x RWM)



AMFR

Lake/Univ. Crown	Roundback	PN#	Description	Weight
		710340	6" x 8"	5.20 lbs.
		710331	6" x 10"	8.40 lbs.
		710341	8" x 6"	4.90 lbs.
		710367	8" x 10"	7.20 lbs.
		710369	10" x 6"	8.00 lbs.
		710368	10" x 8"	7.40 lbs.

AMFR Adapter Male x Female Ringlock Aluminum

FEMALE REDUCER

Ringlock Female x Ringlock Female Coupler (RWM x RWM)



RFFR

Lake/Univ. Crown	Roundback	PN#	Description	Weight
		710387	8" x 6"	5.40 lbs.
		710389	10" x 6"	7.40 lbs.
		710388	10" x 8"	7.70 lbs.

RFFR Reducer Female x Female Ringlock Aluminum



FABRICATED FITTINGS ALUMINUM

REDUCING CONES



CS

Lake/Univ. Crown	Roundback	PN#	Description	Weight
		710632	3"x2"	.31 lbs.
		710633	4"x2"	.52 lbs.
		710634	4"x3"	.35 lbs.
		710630	5"x4"	.94 lbs.
		710635	6"x4"	.79 lbs.
		710636	6"x5"	.93 lbs.
		710637	8"x6"	1.25 lbs.
		710639	10"x8"	1.73 lbs.
		710641	12"x10"	1.73 lbs.

CS Reducing Cones Aluminum

WELD-ON HALF NIPPLE

(3-14 Inch Long with 1-1/2" Inch Std. Pipe Thread)



HN

Lake/Univ. Crown	Roundback	PN#	Description	Weight
		710862	2" x 2 1/2"	.10 lbs.
		710863	3" x 3"	.40 lbs.
		710864	4" x 3 1/4"	.62 lbs.
		710865	5"	1.27 lbs.
		710866	6"	2.10 lbs.
		710868	8"	2.86 lbs.

HN Half Nipple W x MIPT Aluminum

WELD-ON DOME



DM

Lake/Univ. Crown	Roundback	PN#	Description	Weight
		710666	6"	.73 lbs.
		710668	8"	2.17 lbs.
		710669	10"	3.08 lbs.

Weld-on Dome Aluminum

WELD-ON 90 DEGREE ELBOW



WEL

Lake/Univ. Crown	Roundback	PN#	Description	Weight
		710644	4"	1.18 lbs.
		710646	6"	2.97 lbs.
		710648	8"	4.88 lbs.
		710649	10"	7.25 lbs.

WEL Weld-on 90 Degree Elbow Aluminum

WELD-ON TEE



WEL

Lake/Univ. Crown	Roundback	PN#	Description	Weight
		710126	6"	4.26 lbs.
		710128	8"	6.72 lbs.
		710130	10"	9.67 lbs.

WEL Weld-on Tee Aluminum



FABRICATED FITTINGS ALUMINUM

WELD-ON FITTING END

(Includes Band & Latch)



WFE

Lake/Univ.	Crown	Roundback	PN#	Description	Weight
			710672	2"	1.28 lbs.
			710673	3"	1.76 lbs.
			710674	4"	2.30 lbs.
			710675	5"	3.23 lbs.
			710676	6"	3.93 lbs.

WFE Male Weld-on Latch Fitting End Aluminum

WELD-ON DISC



DW

Lake/Univ.	Crown	Roundback	PN#	Description	Weight
			710652	2"	.06 lbs.
			710653	3"	.08 lbs.
			710654	4"	.50 lbs.
			710656	6"	1.00 lbs.
			710658	8"	1.60 lbs.
			710659	10"	1.88 lbs.

DW Weld-on Disc Aluminum

LATCH EAR*



*Specify type of fitting to be welded to.

Lake/Univ.	Crown	Roundback	PN#	Description	Weight
			710452		.03 lbs.

Latch Ear (Travis) Aluminum

LATCH CATCH*



*Specify type of fitting to be welded to.

Lake/Univ.	Crown	Roundback	PN#	Description	Weight
			710453	6"	.03 lbs.

Latch Catch Aluminum



LATERAL COUPLINGS LATCH, STEEL

STEEL LATERAL COUPLER ASSEMBLY

WITH 3/4" NPT RISER OUTLET*
(Includes Female Coupler, Gasket, Band and Latch)



(Crown Style)

SWLA

Lake/Univ.	Crown	Roundback	PN#	Description	Weight
			716000	2"	4.15 lbs.
716453	716001	717711		3"	4.10 lbs.
716454	716002	717712		4"	6.35 lbs.

SWLA Lateral Coupler Assembly 3/4" Riser Outlet Steel (Associated)

LK 3"	716232, 716258, 717307	LK 4"	716235, 716259, 717308
CR 2"	716009, 716028, 717306	CR 3"	716010, 716029, 717307
CR 4"	716011, 716030, 717308		
RB 3"	710423, 716258, 717717	RB 4"	710424, 716259, 717718

STEEL LATERAL PRESS-ON COUPLER



(Crown Style)

SWL

Lake/Univ.	Crown	Roundback	PN#	Description	Weight
			716009	2" w/ 3/4" FIPT	3.60 lbs.
716232	716010	717717		3" w/ 3/4" NPT	3.45 lbs.
				Riser Outlet	
716235	716011	717718		4" w/ 3/4" FIPT	5.0 lbs.
				Riser Outlet	
716233	716013	717719		3" w/ 1" FIPT	3.45 lbs.
				Riser Outlet	
716236	716014	717720		4" w/ 1" FIPT	5.000 lbs.
				Riser Outlet	

SWL Lateral Coupler Press-on Steel

STEEL BAND & LATCH



SBL

Lake/Univ.	Crown	Roundback	PN#	Description	Weight
			716028	2"	1.00 lbs.
716258	716029			3"	1.25 lbs.
716259	716030			4"	1.50 lbs.

SBL Band and Latch Assembly Steel

STEEL END PLUG

(Includes Latch, Spring, Nut and Bolt)



SEP

Lake/Univ.	Crown	Roundback	PN#	Description	Weight
			716033	2"	2.00 lbs.
716200	716034			3"	2.60 lbs.
716201	716035			4"	3.40 lbs.

SEP End Plug Latch Steel

STEEL PRESS-ON CENTER RISER

With 1" NPT Riser Outlet



SCR

Lake/Univ.	Crown	Roundback	PN#	Description	Weight
			757005	3"	3.90 lbs.
			757006	4"	4.90 lbs.

SCR Steel Press-on Center Riser with foot – no drain



LATERAL COUPLINGS LATCH, STEEL

STEEL 90-DEGREE ELBOW

SMFL



(Crown Style)

Lake/Univ.	Crown	Roundback	ÚPÀ	Description	Weight
	716038			2"	5.00 lbs.
716238	716039	717723		3"	6.00 lbs.
716239	716040	717724		4"	8.12 lbs.

SMFL Lateral 90 Degree Elbow Steel

STEEL 45-DEGREE ELBOW

SMFL



(Crown Style)

Lake/Univ.	Crown	Roundback	ÚPÀ	Description	Weight
	716043			2"	3.25 lbs.
716244	716044	717727		3"	5.50 lbs.
716245	716045	717728		4"	6.67 lbs.

SMFL Lateral 45 Degree Elbow Steel

STEEL LINE TEE

SLT



(Univ Shown)

Lake/Univ.	Crown	Roundback	ÚPÀ	Description	Weight
	716048			2"	7.00 lbs.
716212	716049	717731		3"	7.50 lbs.
716213	716050	717732		4"	9.48 lbs.

SLT Line Tee Latch Steel

STEEL END TEE

SET



(Crown Style)

Lake/Univ.	Crown	Roundback	ÚPÀ	Description	Weight
	716053			2"	5.00 lbs.
716206	716054	717735		3"	6.50 lbs.
716207	716055	717736		4"	7.79 lbs.

SET End Tee Latch Steel



STEEL LATCH ASSEMBLY

(4" & 6" Includes Gasket, Female Coupling, Steel Band & Latch) (8" Includes Gasket, Female & Male Couplings)



(Univ shown)

SLA

Lake/Univ.	Crown	Roundback	PN#	Description	Weight
716284	716086	717754		4"	4.75 lbs.
716286	716088	717756		6"	8.25 lbs.
716288				8"	11.10 lbs.

SLA Latch Assembly Steel (Associated)

LK 4"	716223,	716259,	717308	4"	
LK 6"	716224,	716260,	717310	6"	5.60 lbs.
LK 8"	710418,	716250,	716255	8"	
CR 4"	716030,	716091,	717308	4"	
CR 6"	716032,	716093,	717310	6"	
RB 4"	710424,	716259,	717758	4"	
RB 6"	710426,	716260,	717760	6"	

STEEL LATCH PRESS-ON FEMALE COUPLER



(Univ shown)

SLF

Lake/Univ.	Crown	Roundback	PN#	Description	Weight
	716090	717757		3"	1.50 lbs.
716223	716091	717758		4"	3.25 lbs.
716224	716093	717760		6"	5.60 lbs.
716250				8"	7.20 lbs.

SLF Latch Female x Press-on Steel (double hook boss on 8")

STEEL LATCH PRESS-ON MALE COUPLER



SLM

Lake/Univ.	Crown	Roundback	PN#	Description	Weight
716253				4"	3.00 lbs.
716254				6"	7.00 lbs.
716255				8"	11.70 lbs.

SLM Latch Male x Press-on Coupler Steel (double latch on 8")

STEEL BAND & LATCH

(Includes Band, Latch, Bolt, Nut & Spring)



SBL

Lake/Univ.	Crown	Roundback	PN#	Description	Weight
716259	716030			4"	1.50 lbs.
716260	716032			6"	2.50 lbs.

SBL Band and Latch Steel



STEEL END PLUG



(8" Shown)

SEP

Lake/Univ.	Crown	Roundback	PN#	Description	Weight
716201	716035			4"	3.40 lbs.
716202	716037			6"	6.30 lbs.
716203				8"	7.90 lbs.

SEP End Plug Latch Steel
(Double Latch Standard 8" Only)

**STEEL LATCH
WELD-ON
FEMALE COUPLER**



(8" Shown)

SLWF

Lake/Univ.	Crown	Roundback	PN#	Description	Weight
716961	716095	717761		3"	1.60 lbs.
716962	716096	717762		4"	2.60 lbs.
716963	716098	717764		6"	4.75 lbs.
716964				8"	7.00 lbs.

SLWF Female x Weld-on Latch Coupler Black Steel
(Double Latch Standard 8" Only)
(2" - 6" Single Hook)

**STEEL LATCH
WELD-ON
MALE COUPLER**

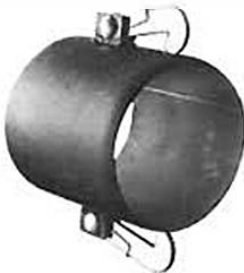

(8" Shown)

SLWM

Lake/Univ.	Crown	Roundback	PN#	Description	Weight
	717000			2"	1.09 lbs.
716967	717001			3"	2.20 lbs.
716968	717002			4"	2.90 lbs.
716969	717005			6"	4.50 lbs.
716970				8"	6.00 lbs.

SLWM Male x Weld-on Coupler Latch Steel (Black)
(Double Latch Standard 8" Only)



MAINLINE LATCH, STEEL

STEEL 90 DEGREE ELBOW



SMFL

Lake/Univ.	Crown	Roundback	PN#	Description	Weight
716239	716040	717724		4"	8.12 lbs.
716240	716042	717726		6"	17.00 lbs.
716241				8"	25.00 lbs.

SMFL Lateral 90 Degree Elbow Steel

STEEL 45 DEGREE ELBOW



SMFL

Lake/Univ.	Crown	Roundback	PN#	Description	Weight
716245	716045	717728		4"	6.67 lbs.
716246	716047	717730		6"	14.00 lbs.
716247				8"	21.50 lbs.

SMFL Lateral 45 Degree Elbow Steel

STEEL LINE TEE



SLT

Lake/Univ.	Crown	Roundback	PN#	Description	Weight
716213	716050	717732		4"	9.48 lbs.
716214	716052	717734		6"	23.00 lbs.
716215				8"	25.66 lbs.

SLT Line Tee Latch Steel

STEEL END TEE



SET

Lake/Univ.	Crown	Roundback	PN#	Description	Weight
716207	716055	717736		4"	7.79 lbs.
716208	716057	717738		6"	19.00 lbs.
716209				8"	27.50 lbs.

SET End Tee Latch Steel



VALVES LATCH, STEEL

STEEL LATCH PRESS-ON VALVE ASSEMBLY



(4" & 6" Includes Female End, Gasket, Band & Latch)
(8" Includes Male End, Female End & Gasket)

Lake/Univ.	Crown	Roundback	PN#	Description	Weight
716974	717115	717809		4"x4"	11.00 lbs.
716976	717117	717811		6"x4"	14.00 lbs.
716978				8"x4"	28.13 lbs.

SLVA Valve Assembly Latch Steel (Associated)

LK 4"	716218,	716259,	717308		
LK 6"	716219,	716260,	717310		
LK 8"	710418,	716220,	716255		
CR 4"	716030,	717120,	717308		
CR 6"	716032,	717122,	717310		
RB 4"	710424,	716259,	717814		
RB 6"	710426,	716260,	717816		

STEEL LATCH PRESS-ON VALVE



Lake/Univ.	Crown	Roundback	PN#	Description	Weight
716218	717120	717814		4"x4"	9.50 lbs.
716219	717122	717816		6"x4"	11.50 lbs.
716220				8"x4"	19.70 lbs.

SLV Valve Latch x Press-on Steel (Single Latch)

STEEL LATCH MALE BY FEMALE VALVE



Lake/Univ.	Crown	Roundback	PN#	Description	Weight
716951	717125	717819		4"x4"	11.00 lbs.
716952	717127	717821		6"x4"	16.85 lbs.
716953				8"x4"	21.45 lbs.

SMFV Valve Male x Female Latch Steel (Single Latch)

STEEL LATCH MAINLINE VALVE



Lake/Univ.	Crown	Roundback	PN#	Description	Weight
716956				4"	8.95 lbs.
716957				6"	14.00 lbs.
716958				8"	18.26 lbs.

SMV Valve Female x Female Latch Steel



STEEL RINGLOCK ASSEMBLY

(Includes Male End, Female End, Clamp & Gasket)



SRA

Lake/Univ.	Crown	Roundback	PN#	Description	Weight
	716894	717765		4"	6.90 lbs.
	716896	717767		6"	11.75 lbs.
	716898	717768		8"	16.40 lbs.
	716899	717769		10"	21.00 lbs.
	716900	717770		12"	26.00 lbs.

Ringlock Assembly Steel (Associated)

CR 4"	716078,	716704,	716714,	717308	
CR 6"	716080,	716706,	716716,	717310	
CR 8"	710418,	716081,	716708,	716718	
CR 10"	710419,	716082,	716709,	716719	
CR 12"	710421,	716083,	716710,	716720	
RB 4"	710424,	716078,	716704,	717771	
RB 6"	710426,	716080,	716706,	717773	
RB 8"	710428,	716081,	716708,	717774	
RB 10"	710429,	716082,	716709,	717775	
RB 12"	710442,	716083,	716710,	717776	

STEEL RINGLOCK PRESS-ON FEMALE COUPLER



SRF

Lake/Univ.	Crown	Roundback	PN#	Description	Weight
	716714	717771		4"	2.75 lbs.
	716716	717773		6"	5.30 lbs.
	716718	717774		8"	7.70 lbs.
	716719	717775		10"	8.70 lbs.
	716720	717776		12"	11.45 lbs.

SRF Ringlock Coupler Female x Press-on Steel

STEEL RINGLOCK PRESS-ON MALE



SRM

Lake/Univ.	Crown	Roundback	PN#	Description	Weight
	716704			4"	2.30 lbs.
	716706			6"	3.30 lbs.
	716708			8"	6.00 lbs.
	716709			10"	7.20 lbs.
	716710			12"	10.00 lbs.

SRM Ringlock Coupler Male x Press-on Steel

MAINLINE HOLD BAND



(Must be used on all 4"-12" press-in type couplers except for gated pipe)

MHB

Lake/Univ.	Crown	Roundback	PN#	Description	Weight
	716904			4"	.13 lbs.
	716906			6"	.50 lbs.
	716908			8"	.75 lbs.
	716909			10"	.88 lbs.
	716910			12"	1.00 lbs.

MHB Hold Bands Aluminum



RINGLOCK CLAMP



RLC

Lake/Univ.	Crown	Roundback	PN#	Description	Weight
	716080			6"	2.18 lbs.
	716081			8"	2.70 lbs.
	716082			10"	3.20 lbs.
	716083			12"	5.00 lbs.

RLC Ringlock Clamp Steel (Silver Color)

STEEL RINGLOCK 90 DEGREE ELBOW



SRMFL

(Crown Shown)

Lake/Univ.	Crown	Roundback	PN#	Description	Weight
	716774	717795		4"	4.85 lbs.
	716776	717797		6"	11.25 lbs.
	716778	717798		8"	15.30 lbs.
	716779	717799		10"	20.90 lbs.
	716780	717800		12"	28.00 lbs.

SRMFL Ringlock 90 Degree Elbow Steel

STEEL RINGLOCK 45 DEGREE ELBOW



SRMFL

(Crown Shown)

Lake/Univ.	Crown	Roundback	PN#	Description	Weight
	716784	717801		4"	3.75 lbs.
	716786	717803		6"	8.60 lbs.
	716788	717804		8"	12.35 lbs.
	716789	717805		10"	14.40 lbs.
	716790	717806		12"	19.20 lbs.

SRMFL Ringlock 45 Degree Elbow Steel



MAINLINE RINGLOCK, STEEL

STEEL RINGLOCK LINE TEE



(Crown Shown)

SRLT

Lake/Univ. Crown	Roundback	PN#	Description	Weight
716755	717783		4"	6.35 lbs.
716756	717785		6"	14.35 lbs.
716758	717786		8"	20.50 lbs.
716759	717787		10"	26.65 lbs.
716760	717788		12"	36.00 lbs.

SRLT Ringlock Line Tee Steel

STEEL RINGLOCK END TEE



(Crown Shown)

SRET

Lake/Univ. Crown	Roundback	PN#	Description	Weight
716764	717789		4"	6.90 lbs.
716766	717791		6"	14.40 lbs.
716768	717792		8"	20.50 lbs.
716769	717793		10"	27.70 lbs.
716770	717794		12"	36.00 lbs.

SRET Ringlock End Tee Steel

STEEL RINGLOCK END PLUG



SREP

Lake/Univ. Crown	Roundback	PN#	Description	Weight
716794			4"	2.60 lbs.
716796			6"	4.40 lbs.
716798			8"	8.30 lbs.
716799			10"	11.85 lbs.
716800			12"	16.05 lbs.

SREP Ringlock End Plug Steel



MAINLINE RINGLOCK, STEEL

STEEL RINGLOCK WELD-ON FEMALE



SRWF

Lake/Univ.	Crown	Roundback	PN#	Description	Weight
	716734	717777		4"	1.85 lbs.
	716736	717779		6"	3.65 lbs.
	716738	717780		8"	4.20 lbs.
	716739	717781		10"	5.60 lbs.
	716740	717782		12"	7.15 lbs.

SRWF Ringlock Female x Weld-on Black Steel

STEEL RINGLOCK WELD-ON MALE



SRWM

Lake/Univ.	Crown	Roundback	PN#	Description	Weight
	716724			4"	1.75 lbs.
	716726			6"	2.60 lbs.
	716728			8"	3.80 lbs.
	716729			10"	5.30 lbs.
	716730			12"	6.00 lbs.

SRWM Ringlock Male x Weld-on Black Steel



VALVES RINGLOCK, STEEL

STEEL RINGLOCK PRESS-ON VALVE ASSEMBLY

(Includes Male End, Female Valve Tee, Clamp & Gasket)



SRVA

Lake/Univ.	Crown	Roundback	PN#	Description	Weight
	716914	717822		4"x4"	11.50 lbs.
	716916	717824		6"x4"	17.68 lbs.
	716918	717825		8"x4"	22.10 lbs.
	716919	717826		10"x4"	36.95 lbs.
	716920	717827		12"x4"	39.00 lbs.

SRVA Ringlock Press-on Valve Assembly Steel (Associated)

CR 4"	716078,	716704,	716744,	717308	
CR 6"	716080,	716706,	716746,	717310	
CR 8"	710418,	716081,	716708,	716748	
CR 10"	710419,	716082,	716709,	716749	
CR 12"	710421,	716083,	716710,	716750	
RB 4"	710424,	716078,	716704,	717831	
RB 6"	710426,	716080,	716706,	717033	
RB 8"	710428,	716081,	716708,	717834	
RB 10"	710429,	716082,	716709,	717835	
RB 12"	710442,	716083,	716710,	717836	

STEEL RINGLOCK PRESS-ON VALVE

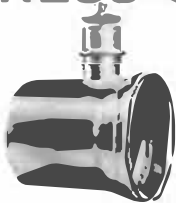

SRV

Lake/Univ.	Crown	Roundback	PN#	Description	Weight
	716744	717831		4"x4"	7.25 lbs.
	716746	717833		6"x4"	11.25 lbs.
	716748	717834		8"x4"	13.25 lbs.
	716749	717835		10"x4"	19.20 lbs.
	716750	717836		12"x4"	22.15 lbs.

SRV Ringlock Valve Female x Press-on Steel

STEEL RINGLOCK MALE-FEMALE VALVE



SRMFV

Lake/Univ.	Crown	Roundback	PN#	Description	Weight
	716924	717840		4"x4"	24.50 lbs.
	716926	717842		6"x4"	10.35 lbs.
	716928	717843		8"x4"	10.10 lbs.
	716929	717844		10"x4"	19.30 lbs.
	716930	717845		12"x4"	24.50 lbs.

SRMFV Ringlock Valve Male x Female Steel

STEEL RINGLOCK MAINLINE VALVE



SRMV

Lake/Univ.	Crown	Roundback	PN#	Description	Weight
	716934	717863		4"x4"	8.00 lbs.
	716936	717864		6"x4"	12.50 lbs.
	716938	717865		8"x4"	15.00 lbs.
	716939	717866		10"x4"	17.50 lbs.
	716940	717867		12"x4"	20.70 lbs.

SRMV Ringlock Valve Female x Female Steel



VALVES RINGLOCK, STEEL

4" STEEL RINGLOCK VALVE OPENING ELBOW



SRVL

Lake/Univ.	Crown	Roundback	PN#	Description	Weight
	715588	715593		4"x3"	8.00 lbs.
	715589	715595		4"x4"	8.50 lbs.

SRVL Ringlock Valve Opening Elbow 3/4" Outlet Steel
Additional sizes available

4" STEEL RINGLOCK VALVE OPENING TEE



SRVT

Lake/Univ.	Crown	Roundback	PN#	Description	Weight
	715580	715582		4"x3"x3"	12.00 lbs.
	715581	715583		4"x4"x4"	13.00 lbs.

SRVT Ringlock Valve Opening Tee 3/4" Outlet Steel
Additional sizes available

STEEL VALVE HANDLE



SVH

Lake/Univ.	Crown	Roundback	PN#	Description	Weight
	717341			(SVH)	

SVH Valve Opener Handle Steel



VALVES RINGLOCK, STEEL

4" STEEL RINGLOCK STUB VALVE



SRSV

Lake/Univ. Crown	Roundback	PN#	Description	Weight
		716754	4"x6"	2.25 lbs.
		717358	6"x6"	8.00 lbs.

SRSV Ringlock Stub Valve Weld-on Steel
Additional sizes available

4" THREADED VALVE

(4" SRSV X 4" or 3" Female NPT Thread)



SRTFV

Lake/Univ. Crown	Roundback	PN#	Description	Weight
		716872	3"x4"	5.00 lbs.
		716874	4"x4"	6.00 lbs.

SRTFV Ringlock Valve FIPT x Valve Steel
Additional sizes available

4" MALE THREADED VALVE

(4" SRSV X 4" Male NPT Thread)



SRTMV

Lake/Univ. Crown	Roundback	PN#	Description	Weight
		717172	3"x4"	5.00 lbs.
		716884	4"x4"	6.00 lbs.

SRTMV Ringlock Valve MIPT x Valve Steel
Additional sizes available



CHANGE-OVERS STEEL

STEEL CHANGE-OVER MALE (Latch x MIPT)



SAML

Lake/Univ.	Crown	Roundback	PN#	Description	Weight
			717518	3"	4.50 lbs.
			717519	4"	6.65 lbs.
			717521	6"	11.00 lbs.
			716644	8"	13.00 lbs.

SAML Change-Over Adapter Male Steel

STEEL CHANGE-OVER FEMALE (Male NPT Thread x Female Latch Coupler)



SAFL

Lake/Univ.	Crown	Roundback	PN#	Description	Weight
716661	717177	717868		3"	4.20 lbs.
716662	717178	717871		4"	6.35 lbs.
716663	717180	717876		6"	11.32 lbs.
716664				8"	14.00 lbs.

SAFL Change-Over Female Steel

STEEL MALE BY FEMALE ADAPTER (Male Latch x Female Latch Coupler)



SAMF

Lake/Univ.	Crown	Roundback	PN#	Description	Weight
716391				3"x4"	6.56 lbs.
716392	717183			4"x3"	6.20 lbs.
		717877		4"x3"	7.00 lbs.
716393				4"x6"	11.50 lbs.
		717880		6"x4"	9.50 lbs.
	717186			6"x4"	9.00 lbs.
716394				6"x4"	10.81 lbs.
716404				6"x8"	17.75 lbs.
716396				8"x6"	16.81 lbs.

SAMF Change-Over Adapter Male x Female Latch Reducer Steel

STEEL FEMALE REDUCER (Female Latch x Female Latch Coupler)



SRFL

Lake/Univ.	Crown	Roundback	PN#	Description	Weight
716416				4"x3"	6.00 lbs.
716417				6"x4"	9.00 lbs.
716418				8"x6"	13.81 lbs.

SRFL Change-Over Reducer Female Latch Steel



CHANGE-OVERS STEEL

STEEL CHANGE-OVER

Male Latch x Ringlock Coupler,
Galvanized



SCORL

Lake/Univ.	Crown	Roundback	PN#	Description	Weight
			716423	4"	3.00 lbs.
			716424	6"	7.00 lbs.
			716425	8"	10.98 lbs.

SCORL Adapter Male LatchxFemale Ringlock Steel

STEEL MAINLINE COUPLER

Female x Female Coupler,
Galvanized



SMC

Lake/Univ.	Crown	Roundback	PN#	Description	Weight
			716428	4"	5.00 lbs.
			716429	6"	8.00 lbs.
			716430	8"	12.06 lbs.

SMC Mainline Coupler Latch Steel



CHANGE-OVERS STEEL

STEEL CHANGE-OVER MALE

Male Thread x Ringlock Male Coupler, Galvanized



SAMR

Lake/Univ.	Crown	Roundback	PN#	Description	Weight
			716634	4"	5.00 lbs.
			716636	6"	10.00 lbs.
			716638	8"	12.75 lbs.
			716639	10"	15.60 lbs.

SAMR Adapter Male Ringlock x MIPT Steel

STEEL CHANGE-OVER FEMALE

Male Thread x Ringlock Female Coupler



SAFR

Lake/Univ.	Crown	Roundback	PN#	Description	Weight	
			716654	717882	4"	4.50 lbs.
			716656	717887	6"	10.00 lbs.
			716658	717889	8"	12.90 lbs.
			716659	717891	10"	16.00 lbs.
			716660	717893	12"	17.10 lbs.

SAFR Adapter Female Ringlock x MPT Steel

STEEL MALE BY FEMALE ADAPTER

Ringlock Male x Female Coupler



SAMFR

Lake/Univ.	Crown	Roundback	PN#	Description	Weight	
			716371	717894	4"x6"	7.00 lbs.
			716372	717896	6"x4"	7.00 lbs.
			716373	717898	6"x8"	9.50 lbs.
			716374	717899	6"x10"	14.00 lbs.
			716375	717900	8"x6"	11.75 lbs.
			716376	717901	8"x10"	14.80 lbs.
			716377	717902	8"x12"	22.00 lbs.
			716378	717903	10"x6"	16.50 lbs.
			716379	717904	10"x8"	14.80 lbs.
			716380	717905	10"x12"	18.00 lbs.
			716381	717907	12"x10"	19.00 lbs.
			716382	717906	12"x8"	18.00 lbs.

SAMFR Reducer Male x Female Ringlock Adapter Steel

STEEL FEMALE REDUCER

Ringlock Female x Female Coupler



SRFR

Lake/Univ.	Crown	Roundback	PN#	Description	Weight	
			716410	717908	6"x4"	8.81 lbs.
			716411	717909	8"x6"	13.18 lbs.
			716412	717910	10"x6"	18.68 lbs.
			716413	717911	10"x8"	16.00 lbs.
			716414	717912	12"x8"	22.93 lbs.
			716415	717913	12"x10"	20.93 lbs.

SRFR Reducer Female Ringlock Steel



FABRICATED FITTINGS STEEL

STEEL REDUCING CONE BLACK



SCS

Lake/Univ. Crown Roundback	PN#	Description	Weight
	717214	3"x2"	.30 lbs
	717215	2"x4"	1.00 lbs.
	717216	4"x3"	.45 lbs.
	717217	5"x3"	1.50 lbs.
	717218	6"x3"	1.95 lbs.
	717219	5"x4"	.65 lbs.
	717220	6"x4"	1.55 lbs.
	717221	8"x4"	3.90 lbs.
	717222	6"x5"	.75 lbs.
	717223	7"x5"	2.75 lbs.
	717224	8"x5"	2.95 lbs.
	717225	7"x6"	2.50 lbs.
	717942	8"x7"	2.60 lbs.
	717226	8"x6"	2.70 lbs.
	717227	9"x8"	2.90 lbs.
	717228	10"x8"	3.00 lbs.
	717230	12"x10"	4.00 lbs.

SCS Reducing Cone Black Steel

STEEL ECCENTRIC REDUCING CONE BLACK

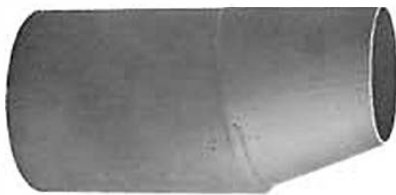

SEC

Lake/Univ. Crown Roundback	PN#	Description	Weight
	716581	2"x3"	2.25 lbs.
	716582	2"x4"	3.00 lbs.
	716583	3"x4"	2.50 lbs.
	716584	3"x5"	3.75 lbs.
	716586	3"x6"	3.25 lbs.
	716585	4"x5"	5.00 lbs.
	716587	4"x6"	4.25 lbs.
	716589	4"x8"	10.50 lbs.
	716588	5"x6"	3.75 lbs.
	716597	8"x5"	10.00 lbs.
	716598	8"x6"	8.75 lbs.
	716592	10"x6"	14.00 lbs.
	716593	10"x8"	12.50 lbs.
	716595	12"x8"	13.50 lbs.
	716596	12"x10"	13.00 lbs.

SEC Eccentric Reducing Cone Black Steel

HALF NIPPLE

(3-14 Inch Long with 1-1/2" Inch Std. PipeThread)

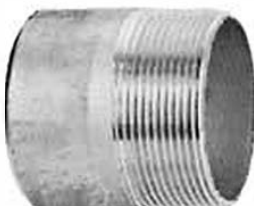

HN

Lake/Univ. Crown Roundback	PN#	Description	Weight
	710808	2"	.90 lbs.
	710809	3"	2.50 lbs.
	710810	4"	3.60 lbs.
	710811	5"	6.30 lbs.
	710812	6"	6.30 lbs.
	710813	8"	6.50 lbs.

HN Half Nipple W x MIPT Weld-on Steel



FABRICATED FITTINGS STEEL

STEEL WELD-ON TEE

BLACK



SWET

Lake/Univ. Crown Roundback PN#	Description	Weight
716833	3"	3.05 lbs.
716834	4"	4.45 lbs.
716835	5"	6.00 lbs.
716836	6"	7.40 lbs.
716838	8"	15.00 lbs.
716839	10"	19.75 lbs.
716840	12"	34.75 lbs.

SWET Weld-on Tee Black Steel

STEEL WELD-ON 90 DEGREE ELBOW

BLACK



SWEL

Lake/Univ. Crown Roundback PN#	Description	Weight
716813	3"	3.20 lbs.
716814	4"	4.85 lbs.
716815	5"	6.85 lbs.
716816	6"	7.35 lbs.
716818	8"	14.35 lbs.
716819	10"	20.50 lbs.
716820	12"	25.00 lbs.

SWEL Weld-on 90 Degree Elbow Black Steel

STEEL WELD-ON 45 DEGREE ELBOW

BLACK



SWEL

Lake/Univ. Crown Roundback PN#	Description	Weight
716823	3"	2.55 lbs.
716824	4"	3.90 lbs.
716825	5"	4.75 lbs.
716826	6"	5.70 lbs.
716828	8"	8.25 lbs.
716829	10"	13.00 lbs.
716830	12"	17.35 lbs.

SWEL Weld-on 45 Degree Elbow Black Steel



WHEELMOVE SYSTEMS

WHEELMOVE HYDRAULIC MOVER



Crop King

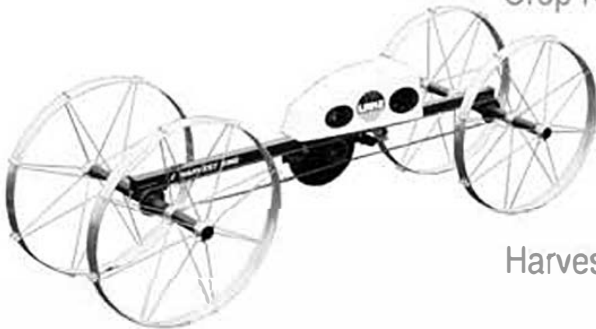

Harvest King

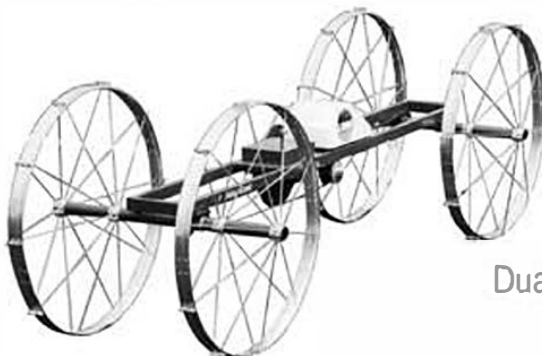

Dual King

Features: Hi-Pressure all-hydraulic power train driven by an 8 HP Briggs & Stratton engine. Dual orbit hydraulic motors feature instant forward & reversing by a single hand control. Unit includes hinged fiberglass engine cover to protect Power Unit. (Wheels and flanged adapters available at extra cost)

WHEELMOVE WHEELS

(Unassembled: Includes 2 Wheel Halves Spokes, Hub-Halves, Cleats, Washers, Nuts)



Lake	Description	Gauge	Weight
730102	5 feet (4" Hub)	18	36.00 lbs.
730103	5 feet (5" Hub)	18	36.00 lbs.
730104	6 feet (4" Hub)	18	47.60 lbs.
730105	6 feet (5" Hub)	18	42.00 lbs.
730106	7 feet (4" Hub)	18	62.00 lbs.
730107	7 feet (5" Hub)	18	62.00 lbs.
730109	8 feet (5" Hub)	16	75.00 lbs.
730116	10 feet (5" Hub)	16	81.00 lbs.

Wheelmove Wheels (Associated)



WHEELMOVE SYSTEMS

SPRAY KING GUN CART (Less Sprinkler)



Crown	Description	Gauge	Weight
717513	Gun Cart		—

WHEELMOVE FLANGE ADAPTER

(Does Not Include Gasket)



Crown	Description	Weight
730146	4"	4.90 lbs.
730147	5"	5.10 lbs.
Wheelmove Flange Adapters x press-on		
730195	4" and 5"	2.55 lbs.

Wheelmove Flange Adapter Gasket

710651	3/8 x 1 1/2 bolt (4 ea)	—
711254	3/8 x 2 1/2 bolt (4 ea)	—
710484	3/8 x nut (8 ea)	—

Bolts

R. O. COUPLER

With 3/4" Steel Riser Outlet



Lake/Univ.	Crown	Description	Weight
730225	730064	4" with 3/4" outlet	—
730224	730066	4" with 1" outlet	—

R.O. Coupler

For HM Hose Hook-up

DRAIN KING TORQUE COUPLERS

Lake/Univ.	Crown	Description	Weight
730525		4" DKTC	—
730526		5" DKTC	—
730552		4" DKTCB 1" SD	—
730553		5" DKTCB 1" SD	—

Drain King Torque Couplers



WHEELMOVE SYSTEMS

TORQUE COUPLER ASSEMBLY* SINGLE DRAIN

(Includes TC, TCB Drain Valve, Gasket and Torque Clamp)
Specify Either 3/4" or 1" Bushing



Lake/Univ. Crown Roundback PN#	Description	Weight
730250	4" with 3/4" Bushing	7.20 lbs.
730260	5" with 3/4" Bushing	9.20 lbs.
730238	4" with 1" Bushing	7.20 lbs.
730241	5" with 1" Bushing	9.20 lbs.

Torque Coupler Assembly (Associated)

TC = Female with gasket grooved

TCBG = Male with riser outlet & drain valve without grooves

TORQUE COUPLER (With Gasket)



TC

Lake/Univ. Crown Roundback PN#	Description	Weight
730132	4"	2.00 lbs.
730137	5"	2.90 lbs.

TC Torque Coupler No Outlet

TORQUE COUPLER (With Riser Outlet)

(Specify Either 3/4" or 1" Bushing)



TCB

Lake/Univ. Crown Roundback PN#	Description	Weight
730237	4" with 3/4" Bushing	2.90 lbs.
730236	5" with 3/4" Bushing	2.90 lbs.
730239	4" with 1" Bushing	2.90 lbs.
730240	5" with 1" Bushing	4.00 lbs.

TCB Torque Coupler (Associated)

TORQUE COUPLER CLAMP (Fits 4" & 5" TC Sets)



TCC

Lake/Univ. Crown Roundback PN#	Description	Weight
730058	4" and 5"	2.30 lbs.

TCC Torque Coupler Clamp – Heavy Duty

TORQUE COUPLER GASKET (Fits 4" & 5" TC's)



TCG

(Specify Standard or Take-Down Wheeline)

Lake/Univ. Crown Roundback PN#	Description	Weight
730196	4" and 5"	0.03 lbs.

TCG Torque Coupler Gasket

TORQUE COUPLER HOLD BAND



TCHB

Lake/Univ. Crown Roundback PN#	Description	Weight
716904	4"	0.13 lbs.
716905	5"	0.16 lbs.

TCHB Torque Coupler Hold Band Aluminum



WHEELMOVE SYSTEMS

TORQUE COUPLER FLAPPER DRAIN

(For Single Drains 4" or 5" TCB)



TCFD

Lake/Univ. Crown	Roundback	PN#	Description	Weight
		730189	4" or 5"	0.25 lbs.

TCFD Torque Coupler Flapper Drain (Associated)

TORQUE COUPLER DRAIN PLUG

(For Old-Style Double-Drain Couplers)



TCDP

Lake/Univ. Crown	Roundback	PN#	Description	Weight
		730190	4" or 5" plug only	0.03 lbs.
		730186	4" or 5" complete (A)	0.05 lbs.

TCDP Torque Coupler Drain Plug (Associated)
730186 complete 730190, 730191

TORQUE COUPLER DRAIN PLUG CLIP

(For Use With TCDP)



TCDP

Lake/Univ. Crown	Roundback	PN#	Description	Weight
		730191	4" or 5"	0.02 lbs.

TCDP Torque Coupler Drain Plug Clip

TORQUE COUPLER FLUSHING END PLUG

(For 4" or 5" Lines) Double Drain

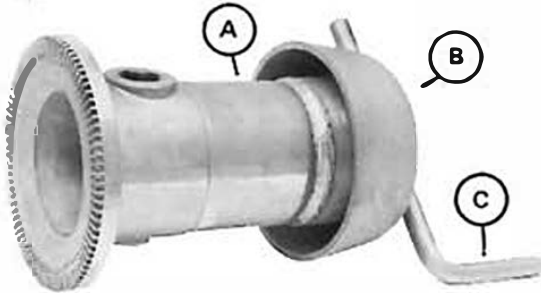

- A) Flushing End Plug Body
- B) Splash Guard Only
- C) Valve Screw And Handle Only

TCEP

Lake/Univ. Crown	Roundback	PN#	Description	Weight
		730178	4" or 5"	6.70 lbs.
		A - 730182	Finish Plug	6.70 lbs.
		B- 730375	End Plug	
			No Outlet	6.20 lbs.
		730299	End Plug Body	
		730510	Splash Guard	1.17 lbs.
		C - 730371	Handle (CRPN68)	

TCEP Torque Coupler Flushing End Plug



WHEELMOVE SYSTEMS

WHEELMOVE SLIP JOINT

(Use with Telescope Coupler)



Lake/Univ.	Crown	Roundback	PN#	Description	Weight
963230				3"x30"	17.70 lbs.

Wheelmove Slip Joint

WHEELMOVE TELESCOPE COUPLER



With 3/4" Steel Riser Outlet
(Galvanized Steel)

Lake/Univ.	Crown	Roundback	PN#	Description	Weight
730176				3"x4" with 3/4" outlet	3.81 lbs.
730177				4"x5" with 3/4" outlet	5.01 lbs.
730174				3"x4" with 1" outlet	3.81 lbs.
730175				4"x5" with 1" outlet	5.01 lbs.

Wheelmove Telescope Coupler

WHEELMOVE HOSE COUPLER

(With 2 Male Ends)



Lake/Univ.	Crown	Roundback	PN#	Description	Weight
730220	730081			4"x20'	30.40 lbs.
730221				4"x25'	37.50 lbs.

Wheelmove Hose Coupler Male End Latch

SPRINKLER LEVELER

(With Sprinkler or Elbow)



Lake/Univ.	Crown	Roundback	PN#	Description	Weight
			730501	3/4"	2.40 lbs.
			730503	1"x 3/4" Elb.	—
			730506	3/4"x3/4" Elb.	—

Sprinkler Leveler

WHEEL-MOVE ADAPTER



Crown	Description	Weight
	731073 WM Adapter TC x RO 1 with gasket	—
	731077 WM Adapter TC x RO w/o gasket	—

Wheelmove Adapter Torque Coupler (Associated)

731073 · 717308, 730073, 730196
731077 · 717308, 730077, 730196



WHEELMOVE SYSTEMS

STEEL FEMALE HOSE ADAPTER

Female Latch Coupler x O.D. Hose End



SFHA

Lake/Univ.	Crown	Roundback	PN#	Description	Weight
716552		717322		4"	4.50 lbs.

SFHA Adapter Hose Barb x Female Latch Steel
• Band not included

STEEL MALE HOSE ADAPTER

Male Latch Coupler x O.D. Hose End



SMHA

Lake/Univ.	Crown	Roundback	PN#	Description	Weight
716555		717327		4"	5.00 lbs.

SMHA Adapter Hose Barb x Male Latch Steel

STEEL THREADED HOSE ADAPTER

NPT Thread x O.D. Hose End



STHA

Lake/Univ.	Crown	Roundback	PN#	Description	Weight
			716558	4" MIPT	4.50 lbs.
			716510	4" FIPT	7.00 lbs.

STHA Steel Threaded Hose Adapter
STHA Adapter Hose Barb x MIPT Steel

CENTER FEED



CF

Lake/Univ.	Crown	Roundback	PN#	Description	Weight
730290		730060		5"	10.50 lbs.

CF Center Feed Latch with Gasket



GATED PIPE ACCESSORIES

GATED COUPLING



GC

Lake/Univ. Crown	Roundback	PN#	Description	Weight
		710566	6"	1.38 lbs.
		710568	8"	1.47 lbs.
		710569	10"	1.75 lbs.
		710581	12"	—

GC Gated Coupling Aluminum
 • For expanded aluminum pipe, Redi Rain style

END CAP



EC

Lake/Univ. Crown	Roundback	PN#	Description	Weight
		710576	6"	2.81 lbs.
		710578	8"	3.55 lbs.
		710579	10"	4.65 lbs.

EC Gated End Cap Aluminum

GATED SPACER JOINT

(Includes FCR Gate)



GSJ

Lake/Univ. Crown	Roundback	PN#	Description	Weight
		710585	5"	5.10 lbs.
		710586	6"	5.76 lbs.
		710588	8"	6.75 lbs.
		710589	10"	9.29 lbs.

GSJ Gated Spacer Joint Aluminum



GATED PIPE ACCESSORIES

GATED ELBOW

(45 & 90 Degree)



GEL

Lake/Univ. Crown	Roundback	PN#	Description	Weight
		710596	6"	5.14 lbs.
		710598	8"	7.80 lbs.
		710599	10"	10.72 lbs.

GEL Gated 90 Degree Elbow Aluminum

GATED END TEE



GET

Lake/Univ. Crown	Roundback	PN#	Description	Weight
		710606	6"	7.93 lbs.
		710608	8"	10.13 lbs.
		710609	10"	16.30 lbs.
		719006	6" w/FCR	7.00 lbs.
		719008	8" w/FCR	7.93 lbs.
		719009	10" w/FCR	16.30 lbs.

GET Gated End Tee Aluminum

GATED LINE TEE



GLT

Lake/Univ. Crown	Roundback	PN#	Description	Weight
		710616	6"	6.59 lbs.
		710618	8"	8.46 lbs.
		710619	10"	16.30 lbs.
		719016	6" w/FCR	6.59 lbs.
		719018	8" w/FCR	8.46 lbs.
		719019	10" w/FCR	16.30 lbs.

GLT Gated Line Tee Aluminum

GATED MAINLINE TEE



GMT

Lake/Univ. Crown	Roundback	PN#	Description	Weight
		710626	6"	8.10 lbs.
		710628	8"	8.45 lbs.
		710629	10"	13.52 lbs.
		710624	6"x6"x8"	8.68 lbs.
		710627	8"x8"x10"	12.64 lbs.
		719026	6" w/FCR	8.10 lbs.
		719028	8" w/FCR	8.45 lbs.
		719029	10" w/FCR	13.52 lbs.

GMT Gated Mainline Tee Aluminum



GATED PIPE ACCESSORIES

OPEN TOP HYDRANT GALVANIZED



OTH

This open top hydrant is made from 22 gauge galvanized steel for corrosion resistance, and comes equipped with rubber gasket, stainless steel clamp, and one large Rite-Flow gate.

This hydrant is used with concrete pipeline risers and expanded end gated pipe for furrow irrigation. Its rubber gasket seals automatically when the hydrant is forced over a concrete riser. Expanded end gated pipe slips easily over the hydrant outlets for quick line assembly.

Standard size hydrants are 48" high with outlets located 19" from the bottom of the hydrant to the center of the outlet. Single and double outlets in other sizes are available.

PN#	Description
710541	17" w/1-6" outlet
711272	17" w/2-8" outlet
711273	17" w/1-10" outlet
710542	19" w/1-6" outlet
711274	19" w/2-6" outlet
711275	19" w/1-8" outlet
711276	19" w/2-8" outlet

PN#	Description
711277	19" w/1-10" outlet
710543	21" w/1-6" outlet
711278	21" w/2-6" outlet
711279	21" w/1-8" outlet
711280	21" w/2-8" outlet
711281	21" w/1-10" outlet
711282	24" w/2-6" outlet

Open Top Hydrant (Associated)

OPEN TOP HYDRANT GASKETS

PN#	Description	Weight	PN#	Description	Weight
710060	15"x7"		710063	18"x12"	0.70 lbs.
710061	15"x9"		710551	19"x9"	1.50 lbs.
710549	17"x8"	1.30 lbs.	710552	19"x13"	1.20 lbs.
710550	17"x10"	1.10 lbs.	710553	21"x17"	1.50 lbs.
710062	18"x10"	0.90 lbs.	711997	24"x17"	

Open Top Hydrant Gaskets

STAINLESS STEEL HYDRANT CLAMPS



PN#	Description	Weight
710555	17"	
710556	19"	
710557	21"	
710558	24"	

Stainless Steel Hydrant Clamps



GATED PIPE ACCESSORIES

FCR GATE



REGULAR

Lake/Univ.	Crown	Roundback	PN#	Description	Weight
			710858	Complete	0.20 lbs.

FCR Gate (Associated)
 • 710859, 710860

GATED PIPE SOCK ASSEMBLY

(Includes Sock & Clip)



GPSA

Lake/Univ.	Crown	Roundback	PN#	Description	Weight
			708572	6" x 36"	.13 lbs.
			708573	8" x 36"	.32 lbs.
			708574	10" x 36"	.33 lbs.
			708575	12" x 36"	.28 lbs.
			708571	36" Sock Only	.13 lbs.
			708570	48" Sock Only	—
			708576	6" Clip Only	—
			708577	8" Clip Only	—
			708578	10" Clip Only	—
			708579	12" Clip Only	—

Gated Pipe Sock Only

Gated Pipe Sock Assembly (Associated)

8" x 36"	708571, 708577
10" x 36"	708571, 708578
12" x 36"	708571, 708579



ALUMINUM PIPE

Torque Tube

4"
5"



- For wheelmoves
- Lengths 30' and 40'

Lateral

2"
3"
4"



- Available any lengths 10' to 40'
- Your choice of available couplers

Gated

6"
8"
10"
12"



- Standard gated spacings 24", 30", 38" and 40"
(Custom spacings extra)
- Available any lengths 20' to 40'
- Available in expanded type steel or aluminum Ringlock Latch Type

Mainline

4"
5"
6"
8"
10"
12"

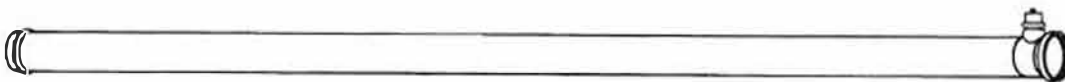

- With or without valves
- Aluminum or steel couplers available any lengths 20' to 50'

Industrial Grooved Pipe

3"
4"
6"
8"
10"
12"



- Steel or aluminum pipe and couplers available any lengths 5' to 40'



ALUMINUM PIPE SPECIFICATIONS

Lake Company Aluminum Pipe Specifications

O.D. (IN.)	PIPE TYPE*	WALL (IN.)	I.D. (IN.)	MAX PIPE WORK PSI	MAX FITTING WORK PSI	MAX TORQUE (IN.-LBS.)	WT/FT. (LBS.)
1-1/4"	L	0.042	1.166	772	80	-	0.203
1-1/2"	L	0.042	1.416	644	80	-	0.232
2"	L	0.05	1.9	575	80	-	0.369
3"	L	0.05	2.9	383	80	-	0.554
3"	V	0.065	2.87	498	498	-	0.72
4"	L,M	0.05	3.9	287	80	-	0.738
4"	W	0.072	3.856	414	200	32,000	1.06
4"	V	0.072	3.856	414	414	-	1.06
5"	G	0.051	4.896	239	N.R.	-	0.942
5"	W	0.078	4.844	357	200	49,000	1.44
5"	W	0.105	4.79	483	200	57,000	1.94
6"	G	0.051	5.898	195	N.R.	-	1.13
6"	M	0.058	5.884	222	80	-	1.28
6"	V	0.083	5.834	318	318	-	1.84
8"	G	0.051	7.898	145	N.R.	-	1.5
8"	M	0.064	7.872	184	80	-	1.89
8"	V	0.083	7.834	237	237	-	2.45
8"	V	0.094	7.812	269	269	-	2.77
10"	M,G	0.064	9.872	147	80	-	2.36
10"	V	0.083	9.834	190	190	-	3.07
10"	V	0.094	9.812	216	216	-	3.47
12"	M,G	0.064	11.872	122	80	-	2.83
12"	V	0.094	11.812	180	180	-	4.17

Notes:

The specifications above are based on Alloy 3004-H26 with a yield strength of 23,000 psi, and a 2 to 1 safety factor. FCR gates have a maximum rating of 20 psi. Rite-Flo gates have a maximum pressure rating of 40 psi.

* L = Lateral, V = Victaulic, M = Mainline, G = Gated, W = Wheeline ** N.R. = Not Rated



EPOXY SADDLES

EPOXY COATED SADDLE

With 4" Plain Stub
(Includes, Nuts & Bolts
Saddle Gasket)



EPOXY COATED SADDLE

With 4" Female NPT Threaded Outlet
(Includes, Nuts & Bolts Saddle Gasket)



* Other threaded outlets on request

EPOXY COATED SADDLE VALVE

With 42" Riser*
(Includes, Nuts & Bolts
Saddle Gasket)



* Other riser lengths available on request

Crown Epoxy	Crown Galv.	Description	Weight
717602	717635	6"x4"	10.50 lbs.
717603	717636	8"x4"	12.50 lbs.
717604	717637	10"x4"	12.50 lbs.
717605	717639	12"x4"	17.50 lbs.

ES Epoxy Coated Saddle with 4" Plain Stub Weld-on

- Also available with 3", 6" & 8" outlets
- Rated at 85 PSI

Crown Epoxy	Crown Galv.	Description	Weight
717612	717618	6"x4"	13.00 lbs.
717613	717619	8"x4"	16.00 lbs.
717614	717620	10"x4"	18.00 lbs.
717615	717621	12"x4"	19.00 lbs.

ESF Epoxy Coated Saddle x FIPT

- Also available with 3", 6" & 8" outlets

Lake/Univ.	Crown	Roundback PN#	Description	Weight
	717638		6"x4"x42"	24.00 lbs.
	717643		8"x4"x42"	26.00 lbs.
	717648		10"x4"x42"	28.00 lbs.
	717653		12"x4"x42"	30.00 lbs.

ESV Epoxy Coated Saddle Valve x Riser with Valve

- Also available with 3", 6" & 8" riser outlets
- Rated at 85 PSI

Crown Epoxy	Crown Galv.	Description	Weight
717606	717623	6"x4"	12.00 lbs.
717607	717624	8"x4"	15.00 lbs.
717608	717625	10"x4"	17.00 lbs.
717609	717626	12"x4"	18.00 lbs.



EPOXY FITTINGS

EPOXY COATED SADDLE

Epoxy	Galvanized	Description	Weight
717606	717623	6" X 4"	0.00 lbs.
717607	717624	8" X 4"	0.00 lbs.
717608	717625	10" X 4"	0.00 lbs.
717609	717626	12" X 4"	0.00 lbs.



Epoxy	Description	Weight
301591	6" IPS Starter weld x gasket	0.00 lbs.
301592	8" IPS Starter weld x gasket	0.00 lbs.
301593	10" IPS Starter weld x gasket	0.00 lbs.
301594	12" IPS Starter weld x gasket	0.00 lbs.
301595	6" PIP Starter weld x gasket	0.00 lbs.
301596	8" PIP Starter weld x gasket	0.00 lbs.
301597	10" PIP Starter weld x gasket	0.00 lbs.
301598	12" PIP Starter weld x gasket	0.00 lbs.
301597	15" PIP Starter weld x gasket	0.00 lbs.



Epoxy	Description	Weight
301564	6" IPS Repair coupler G x G	0.00 lbs.
301565	8" IPS Repair coupler G x G	0.00 lbs.
301566	10" IPS Repair coupler G x G	0.00 lbs.
301567	12" IPS Repair coupler G x G	0.00 lbs.
301568	6" PIP Repair coupler G x G	0.00 lbs.
301569	8" PIP Repair coupler G x G	0.00 lbs.
301570	10" PIP Repair coupler G x G	0.00 lbs.
301571	12" PIP Repair coupler G x G	0.00 lbs.
301572	15" PIP Repair coupler G x G	0.00 lbs.



Epoxy	Description	Weight
301573	6" IPS TEE G x G x G	0.00 lbs.
301574	8" IPS TEE G x G x G	0.00 lbs.
301575	10" IPS TEE G x G x G	0.00 lbs.
301576	12" IPS TEE G x G x G	0.00 lbs.
301577	6" PIP TEE G x G x G	0.00 lbs.
301578	8" PIP TEE G x G x G	0.00 lbs.
301579	10" PIP TEE G x G x G	0.00 lbs.
301580	12" PIP TEE G x G x G	0.00 lbs.

Additional parts available



PUMPS

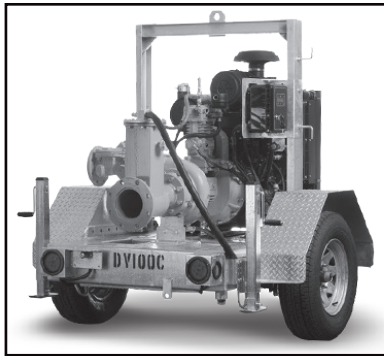

We sell a large variety of Centrifugal (Diesel & Electric), Submersible (Hydraulic & Electric), Diaphragm (AODD), Wellpoint, Vertical, Turbine, Grinder, and Chopper pumps. Get peace of mind you're getting the right fit by sourcing a pump from our selection.

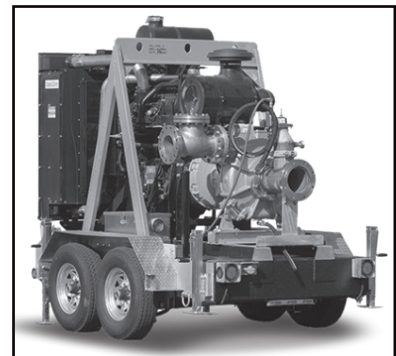
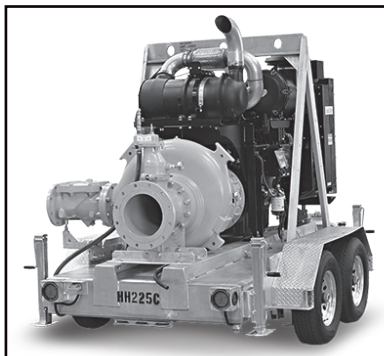

ADDITIONAL PUMP MODELS



EMERGENCY RESPONSE



MUNICIPALITY

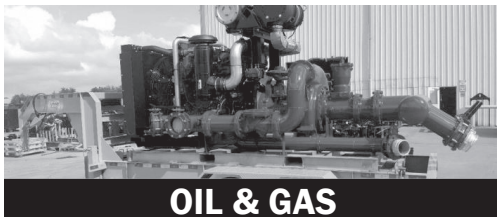

OIL & GAS



DEWATERING

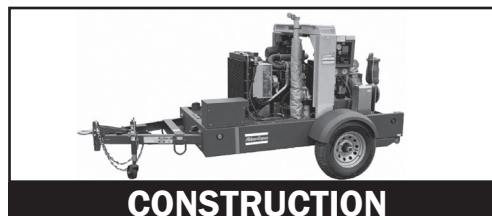

CONSTRUCTION



SPECIALTY PUMPS

ASK ABOUT OUR SPECIALTY PUMPS!

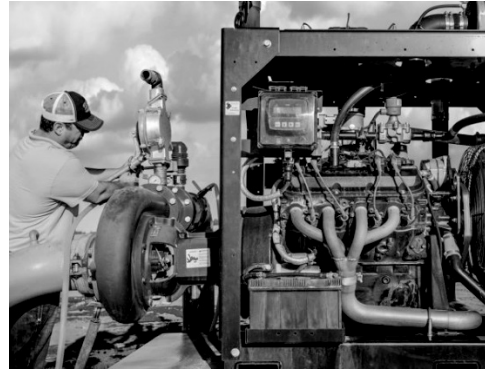
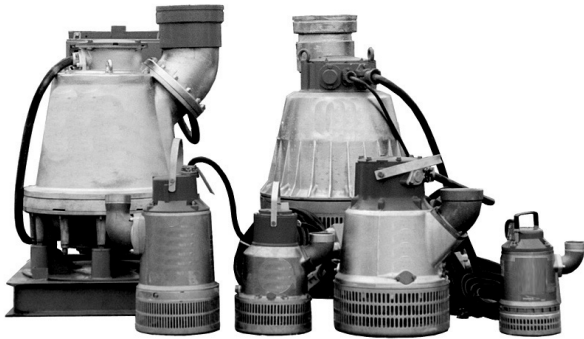

- **Grinder Pumps**
- **Chopper Pumps**
- **Solids Handling Pumps**
- **AODD pumps**
- **Booster Pumps**
- **Sludge Pumps**
- **Slurry Pumps**
- **Vertical Pumps**
- **Drainage Pumps**
- **Turbine Pumps**
- **Electric Submersible**
- **Gas Pumps**
- **Propane Pumps**

Drainage pumps



Sludge pumps



Slurry pumps





PUMP PARTS

**We sell quality
OEM-manufactured
pump parts for all
your pump equipment.
Every part is ready
to ship anywhere
- domestic or
international.**



SERVICING A PUMP? WE CAN HELP WITH PARTS!

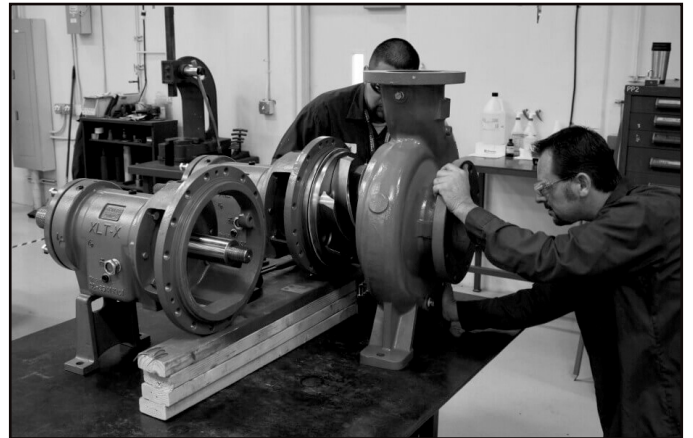

Contact us for a quote!



PUMP ACCESSORIES

PUMP SUCTION AND DISCHARGE SET

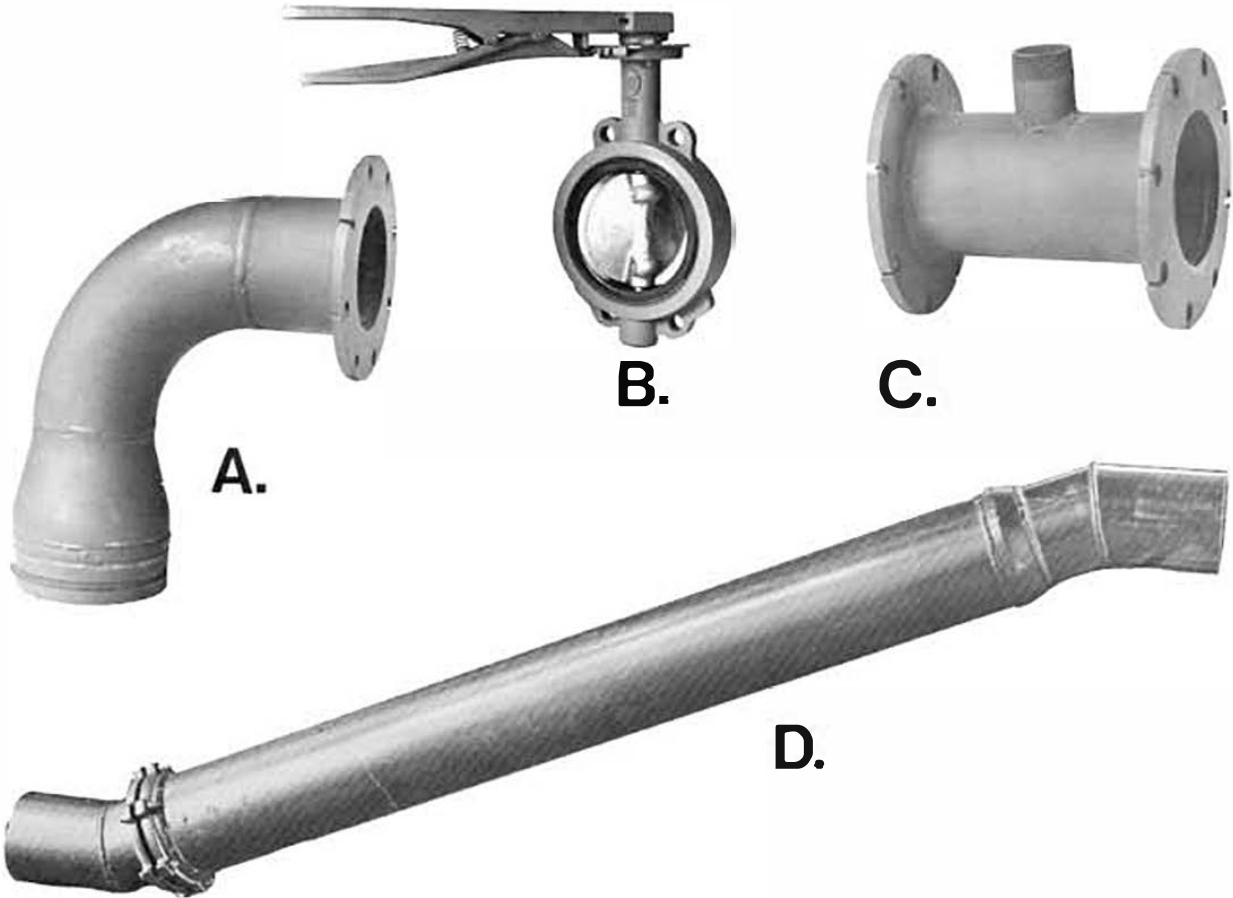

PN# SIZE WEIGHT
A. Steel Discharge Elbow Flanged x VIC

716616	6"x6"	60 lbs.
716619	6"x8"	61 lbs.
716618	8"x8"	64 lbs.

A. Aluminum Discharge Flg x Rwm

710946	6"x6"	—
710936	6"x8"	—
710755	6"x10"	—

B. Butterfly Valve Lever Op WFR

716590	6"	33.00 lbs.
716591	8"	33.00 lbs.
716600	10"	69.00 lbs.

PN# SIZE WEIGHT
C. Steel Discharge Spool Flanged Large Type

716606	6"	26 lbs.
716608	8"	35 lbs.

D. Aluminum Pump Suction

710871	6"x7"	25.5 lbs.
710873	8"x 8 1/2"	27.0 lbs.



PUMP ACCESSORIES

STEEL FLANGED PRESS

(Flange x O.D.), Galvanized



SFPA

Lake/Univ.	Crown	Roundback	PN#	Description	Weight
			716542	2"	4.50 lbs.
			716543	3"	6.40 lbs.
			716544	4"	8.70 lbs.
			716545	5"	10.30 lbs.
			716546	6"	12.45 lbs.
			716548	8"	18.10 lbs.
			716549	10"	22.90 lbs.

SFPA Flanged Press-On Adapter Steel

STEEL RINGLOCK FLANGED DISCHARGE

(Flange x Female Ringlock), Galvanized



SRDF

Lake/Univ.	Crown	Roundback	PN#	Description (A) (B)	Weight	
			716562	717915	3"x6"	11.00 lbs.
			716563	717916	4"x4"	9.30 lbs.
			716564	717918	4"x6"	12.75 lbs.
			716565	717920	5"x6"	13.00 lbs.
			716566	717921	6"x6"	13.45 lbs.
			716567	717922	6"x8"	17.00 lbs.
			716568	717923	8"x8"	16.00 lbs.
			716569	717924	8"x10"	22.60 lbs.
			716599	717925	10"x10"	21.00 lbs.
			716570	717926	10"x12"	22.59 lbs.

SRDF Adapter Flanged x Female Ringlock Steel

STEEL ECCENTRIC FLANGED SUCTION

(Flange x O.D.), Galvanized



SESAF

Lake/Univ.	Crown	Roundback	PN#	Description (A) (B)	Weight	
			716521		2"x3"	5.00 lbs.
			716522		3"x4"	7.70 lbs.
			716524		4"x6"	12.50 lbs.
			716525		5"x6"	11.75 lbs.
			716526		5"x8"	14.00 lbs.
			716527		6"x8"	16.00 lbs.
			716528		8"x10"	18.50 lbs.

SESAF Adapter Eccentric Flange x Press-On Steel

STEEL FLANGED MALE RINGLOCK SUCTION

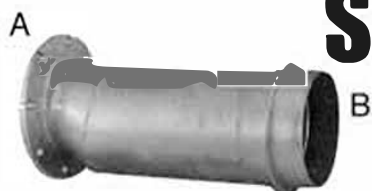

SRDM

Lake/Univ.	Crown	Roundback	PN#	Description (A) (B)	Weight	
			716983		6"x6"	12.35 lbs.
			716984		8"x6"	22.00 lbs.
			716985		8"x8"	18.00 lbs.
			716973		8"x10"	37.85 lbs.

SFMRS Flanged Male Ringlock Suction Galv. Steel



PUMP ACCESSORIES

STEEL ECCENTRIC THREADED SUCTION

(Male Pipe Thd. x O.D.), Galvanized

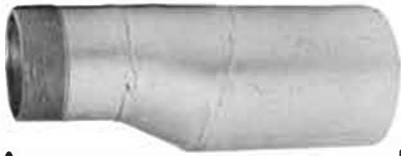

A

B

SESAT

Lake/Univ.	Crown	Roundback	PN#	Description (A) (B)	Weight
			716501	2"x3"	2.75 lbs.
			716502	3"x4"	4.10 lbs.
			716504	4"x6"	7.60 lbs.
			716508	5"x6"	8.60 lbs.
			716505	5"x8"	13.70 lbs.
			716506	6"x8"	12.60 lbs.

SESAT Adapter Eccentric MIPT x Press-On

STEEL THREADED PRESS-IN ADAPTER

(Male Pipe Thd. x O.D.), Galvanized



STPA

Lake/Univ.	Crown	Roundback	PN#	Description	Weight
			716432	2"	2.05 lbs.
			716433	3"	3.00 lbs.
			716434	4"	4.25 lbs.
			716435	5"	6.75 lbs.
			716436	6"	7.80 lbs.
			716438	8"	12.50 lbs.
			716439	10"	15.40 lbs.

STPA Adapter Concentric MIPT x Press-On, Galv.

PUMP SUCTION GASKET



SG

Lake/Univ.	Crown	Roundback	PN#	Description	Weight
			711055	4"	.15 lbs.
			711056	6"	.25 lbs.
			711058	8"	.45 lbs.
			711059	10"	.45 lbs.
			711057	12"	—

SG Suction Gasket



PUMP ACCESSORIES

WELD-ON ALUMINUM FLANGE



FLGA

Lake/Univ.	Crown	Roundback	PN#	Description	Weight
			710804	4"	3.50 lbs.
			710805	5"	5.21 lbs.
			710806	6"	5.80 lbs.
			710807	8"	9.90 lbs.
			710891	10"	11.00 lbs.
			712000	12"	12.00 lbs.

FLGA Weld-On Flange Weld-on Aluminum

FORGED FLANGE STEEL



FRGD

Lake/Univ.	Crown	Roundback	PN#	Description	Weight
				IPS	
			710814	4"	6.70 lbs.
			710815	5"	8.00 lbs.
			710816	6"	8.60 lbs.
			710818	8"	12.50 lbs.
			710819	10"	15.80 lbs.

FRGD IPS Flange Weld-on Steel, Plate 1/2"

FLAME CUT FLANGE STEEL



Lake/Univ.	Crown	Roundback	PN#	Description	Weight
				OD	
			711350	4"	7.25 lbs.
			711351	5"	8.30 lbs.
			710830	6"	9.48 lbs.
			710831	8"	13.46 lbs.
			710832	10"	14.90 lbs.
			711470	12"	21.16 lbs.

Flame-Cut Flange 1/2" O.D. Steel Plate 1/2" (PIP)

FLANGE GASKETS



Full Face Pictured

Lake/Univ.	Crown	Roundback	PN#	Description	Weight
	Full Face			Drop In	
			711430	711091 4"x1/16"	.21 lbs.
			711431	711092 5"x1/16"	.21 lbs.
			711432	711093 6"x1/16"	.24 lbs.
			711433	711094 8"x1/16"	.25 lbs.
			711434	711096 10"x1/16"	.25 lbs.
			711435	711088 12"	.40 lbs.
	(Holes)			(No Holes)	

Flange Gaskets Fiber



PUMP ACCESSORIES

ALUMINUM FOOT VALVE



Lake/Univ.	Crown	Roundback	PN#	Description	Weight
			710902	2"	5.00 lbs.
			710903	3"	7.25 lbs.
			710904	4"	10.92 lbs.
			710905	5"	15.50 lbs.
			710906	6"	32.70 lbs.
			710908	8"	32.70 lbs.
			710909	10"	51.30 lbs.

SFV Foot Valve Standard with Heavy Screen

			710927	4"	40.00 lbs.
			710928	6"	54.00 lbs.
			710929	8"	68.00 lbs.
			710909	10"	51.30 lbs.

SFVJ Foot Valve with Jumbo Screen

PUMP PRIMERS

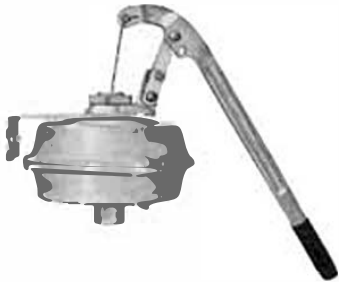

Lake/Univ.	Crown	Roundback	PN#	Description	Weight
			710290	DP7	11.00 lbs.
			710291	DP9	20.00 lbs.
			710292	HP900	18.00 lbs.

Pump Primers

DP7 For 4", 5" & 6" pumps 1/2" inlet, 4" stroke

DP7 For 6", 8" & larger pumps 3/4" inlet, 3 1/2" stroke

HP900 Portable Unit 2" outlet 1 gal. stroke

WATER METERS



Lake/Univ.	Crown	Roundback	PN#	Description	Weight
			710895	4" - 104	40.00 lbs.
			710896	6" - 106	54.00 lbs.
			710897	8" - 108	68.00 lbs.
			710937	10" - 110	87.00 lbs.
			710938	12" - 112	106.00 lbs.

Water Meters



PUMP ACCESSORIES

BRASS GATE VALVE



Lake/Univ. Crown Roundback	PN#	Description	Weight
	711076	1/2"	.60 lbs.
	711077	3/4"	.86 lbs.
	711078	1"	1.03 lbs.
	711079	1 1/4"	1.72 lbs.
	711080	1 1/2"	2.13 lbs.
	711081	2"	3.31 lbs.
	711082	2 1/2"	6.40 lbs.
	711083	3"	8.17 lbs.
	711084	4"	14.75 lbs.

Brass Gate Valve FIPT x FIPT

CHECK VALVE



Lake/Univ. Crown Roundback	PN#	Description	Weight
	710590	6"	122.00 lbs.
	710591	8"	187.00 lbs.
	710592	10"	344.00 lbs.

Check Valve Flanged Cast Iron

DRESSER COUPLING



PN#	Description	Weight	PN#	Description	Weight
711139	3"	7.00 lbs.	711131	2 1/2"	6.25 lbs.
711140	4"	8.00 lbs.	711132	3"	7.25 lbs.
711141	5"	12.69 lbs.	711133	4"	8.50 lbs.
711142	6"	11.50 lbs.	711134	5"	11.50 lbs.
711144	8"	14.30 lbs.	711135	6"	11.25 lbs.
711145	10"	30.50 lbs.	711136	8"	16.00 lbs.
711146	12"	30.70 lbs.	711137	10"	40.00 lbs.
			711138	12"	75.00 lbs.

Dresser Coupling OD

Dresser Coupling Standard IPS

LINE SCREEN



PN#	Description	Weight
710382	2" x 18" Rolled Nose	.50 lbs.
710383	3" x 36" Bull Nosed	1.00 lbs.
710384	4" x 36" Bull Nosed	1.25 lbs.
710385	5" x 36" Rolled End	1.50 lbs.
710386	6" x 36" Rolled End	1.80 lbs.

Line Screen Stainless



FILTRATION ACCESSORIES

6", 8", 10" RINGLOCK FIELD FILTER (Associated)



PN#	DIAMETER	FLOW (GPM)	WEIGHT
710967	6"	750	69.00 lbs.
710035	8"	2200	88.00 lbs.
711029	10"	2600	83.00 lbs.
711711	10" Dual	—	83.00 lbs.

Ringlock Field Filters are ideal for use in areas where irrigation water is muddy, trashy and generally unsuitable to run through a sprinkler system. A stainless steel screen 12' long is used as the filtering media and has orifices of 1/16" diameter. The filters may be flushed while in operation. The filter has a straight through design and may be used either in the line itself or at the pump discharge. Flow capacity ranges from 750 - 2600 GPM.

Ringlock Filters (Associated)

- 6" 490605, 490905, 710051, 710412, 710414, 710416, 710959, 710968, 710969, 710970, 711081
- 8" 490605, 490905, 710052, 710413, 710416, 710418, 710959, 711083, 711436, 711437, 711438
- 10" 490605, 490905, 710053, 710413, 710418, 710419, 710959, 711026, 711027, 711028, 711083
- 10" Dual 304289, 490905, 710053, 710180, 710418, 710419, 711028, 711712, 711713, 711714, 711715

PARTS BREAKDOWN OF FIELD FILTER

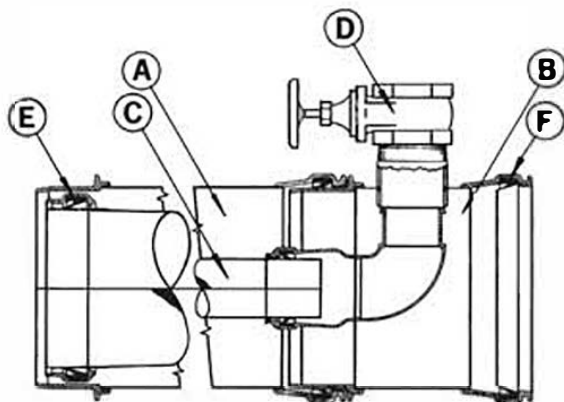

PN#	DESCRIPTION	WEIGHT
A 711026	10" Filter Barrel RL	42.40 lbs.
B 711027	10" Filter Flushing End RL	14.00 lbs.
C 711028	10" Filter Screen RL	17.00 lbs.
D 711083	3" Gate Valve	8.17 lbs.
E 710418	8" Non-Drain Gasket	.38
F 710419	10" Non-Drain Gasket	.42
* 710959	100 PSI Utilizing gauge	—
** 710053	10 RC Ringlock Clamp	—
710413	3" NDG Gasket	—
** 490905	1/2"x1/4" Reducer Bushing	—
** 490605	1/2" NPT Plug	—

** Not pictured



INDUSTRIAL FITTINGS ALUMINUM

WELD-ON INDUSTRIAL GROOVED END



WIE

Crown	Description	Weight	PN#	Description	Weight
Steel			Aluminum		
710733	3"x2"	2.50 lbs.	710683	3"	.69 lbs.
710734	4"x2"	5.50 lbs.	710684	4"	1.12 lbs.
710736	6"x2"	9.60 lbs.	710686	6"	1.89 lbs.
710738	8"x3"	7.14 lbs.	710688	8"	1.59 lbs.
710739	10"x3"	10.12 lbs.	710689	10"	1.99 lbs.
710740	12"x3"	12.39 lbs.	711699	12"	3.20 lbs.

WIE Industrial Grooved Adapter x Weld-On

INDUSTRIAL GROOVED TEE



WIT

Crown	Description	Weight	PN#	Description	Weight
Steel			Aluminum		
710746	6"	26.00 lbs.	710693	3"	4.20 lbs.
710748	8"	45.00 lbs.	710694	4"	6.60 lbs.
710749	10"	100.00 lbs.	710696	6"	10.30 lbs.
711190	12"	140.00 lbs.	710698	8"	12.30 lbs.
			711238	10"	10.30 lbs.

WIT Industrial Grooved Tee

INDUSTRIAL GROOVED ELBOW



WIEL

Crown	Description	Weight	PN#	Description	Weight
Steel			Aluminum		
710756	6"	18.50 lbs.	710703	3"	3.50 lbs.
710758	8"	36.80 lbs.	710704	4"	4.70 lbs.
710759	10"	62.00 lbs.	710706	6"	8.90 lbs.
711191	12"	100.00 lbs.	710708	8"	10.30 lbs.
			711238	10"	10.30 lbs.

WIEL Industrial Grooved 90 Degree Elbow

CHANGE-OVER

Industrial Grooved x Pipe Thread



WIAM

Crown	Description	Weight	PN#	Description	Weight
Steel			Aluminum		
710780	3"	.80 lbs.	710723	3"	1.10 lbs.
710781	4"	1.50 lbs.	710724	4"	1.70 lbs.
710782	6"	3.30 lbs.	710726	6"	4.00 lbs.
710779	8"	5.00 lbs.	710728	8"	4.50 lbs.

WIAM Industrial Grooved Change-Over/Adapter Grooved x MIPT



INDUSTRIAL FITTINGS

INDUSTRIAL GROOVED PLUG



WIP

Crown	Description	Weight	PN#	Description	Weight
Steel			Aluminum		
710846	6"	7.50 lbs.	710839	3"	1.20 lbs.
710848	8"	12.80 lbs.	710840	4"	1.60 lbs.
710845	10"	20.00 lbs.	710841	6"	2.90 lbs.
710847	12"	27.50 lbs.	710842	8"	3.80 lbs.

WIP Industrial Grooved End Plug

INDUSTRIAL VICTAULIC COUPLINGS Style 77



WIC-HW

Crown	Description	Weight
Steel		
710762	2"	2.7 lbs.
710763	3"	4.2 lbs.
710764	4"	7.0 lbs.
710766	6"	13.5 lbs.
710768	8"	23.00 lbs.
710769	10"	31.00 lbs.
710770	12"	35.00 lbs.

WIC Industrial Grooved Couplings Heavy Weight

INDUSTRIAL VICTAULIC COUPLING LIGHT WEIGHT STEEL Style 75



WIC-LW

Crown	Description	Weight
Iron		
710773	3"	2.50 lbs.
710774	4"	3.50 lbs.
710776	6"	6.70 lbs.
710777	8"	12.50 lbs.

WICW Industrial Grooved Couplings Light Weight



GASKETS

NON-DRAIN GASKETS



NDG

For Aluminum	PN#	Description	Weight
	710412	2"	.04 lbs.
	710413	3"	.09 lbs.
	710414	4"	.12 lbs.
	710415	5"	.18 lbs.
	710416	6"	.23 lbs.
	710417	7"	.28 lbs.
	717310	6"	.23 lbs.
	710418	8"	.38 lbs.
	710419	10"	.42 lbs.
	710421	12"	.65 lbs.

NDG Non-Drain Gaskets

OVERSIZE GASKETS

OG

Lake/Univ. Crown	Roundback	PN#	Description	Weight
		717301	3"	.09 lbs.
		717305	4"	.12 lbs.

OG Oversize Gaskets for Aluminum Fittings and RainTite Fittings

ROUND SEATED GASKETS



RSG

Lake/Univ. Crown	Roundback	PN#	Description	Weight
		710422	2"	.13 lbs.
		710423	3"	.19 lbs.
		710424	4"	.25 lbs.
		710425	5"	.31 lbs.
		710426	6"	.38 lbs.
		710427	7"	.44 lbs.
		710428	8"	.56 lbs.
		710429	10"	1.00 lbs.
		710442	12"	.95 lbs.

RSG Round Seated Gaskets For Steel Roundback Couplers













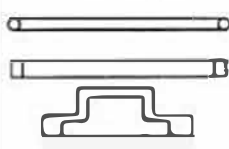
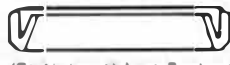



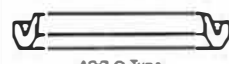
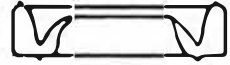



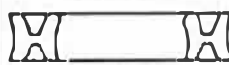

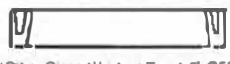
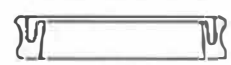
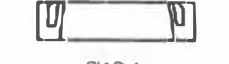
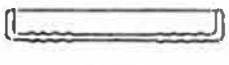

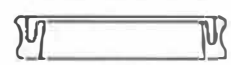
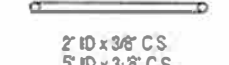
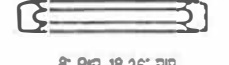
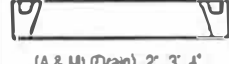



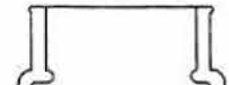



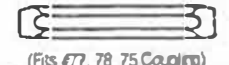







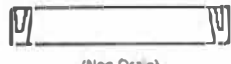
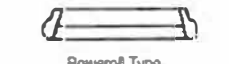

NW

Lake/Univ. Crown	Roundback	PN#	Description	Weight
		717306	2"	—
		717307	3"	—
		717308	4"	—
		717309	5"	—
		717310	6"	—

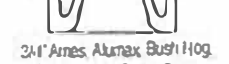
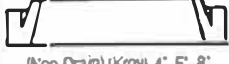
NDG Non Drain Gasket
Chevron Gaskets Fit Crown Steel & Universal

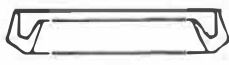
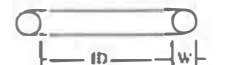

GASKETS

<p>ALUMAX TYPE</p>  <p>Wheel Line 4" Old Style - 4-1/2" ID x 2 1/2" 4" Old Style - 4-1/2" ID x 2 3/4" 1-1/2" Center Ribber Gasket</p>	<p>GREEN TYPE</p>  <p>(Fits Lindsay, Midwest, Band and Hook, Cozad) (Non-Drain) (GHM) 3", 4", 5", 6", 8", 10", 12"</p>	<p>RACE & RACE (LINKLOCK) TYPE</p>  <p>2"</p>	<p>SHUR-RATE TYPE</p>  <p>(Non-Drain) 3", 4", 6", 12"</p>	<p>DRAIN VALVES</p>  <p>Flapper Type 7/8" Hole</p>
<p>AMES TYPE</p>  <p>ABC-O Type 2", 3", 4", 5", 6", 8"</p>	<p>HASTINGS TYPE</p>  <p>12"</p>	<p>RAINBOW TYPE</p>  <p>Demountable 3"</p>	<p>CHEVRON STYLE (Non-Drain)</p>  <p>6"</p>	<p>Mushroom Type Long Shank (No Clip Needed) Long Shank 3/4" width</p> 
<p>ABC-O Type 2", 3", 4", 5", 6", 8"</p>  <p>ABC-OS Type 8"</p> 	<p>IRECO TRAIL LINE TYPE</p>  <p>(Other Sizes - Western Type) 5" GSS</p>	<p>RAIN CONTROL TYPE</p>  <p>(Hardie) 2", 3"</p>	<p>Old Style 2", 3", 6"</p> 	<p>HYDRANT GASKETS</p>  <p>17" X 11"</p>
<p>LO HI Type (LH-O) 6", 8", 11 7/8" OD</p> 	<p>LOCK WOOD TYPE</p>  <p>6-5/8" Pivot</p>	<p>RAINMAKER TYPE</p>  <p>(Non-Drain) 3" (Fits Revit Type Style)</p>	<p>2" ID x 3/8" C.S. 5" ID x 3/8" C.S. 5-3/8" ID x 1/4" C.S.</p> 	<p>PIPE & IPS GASKETS</p>  <p>8" PIP, 18 3/8" PIP</p>
<p>ANDERSON MILLER TYPE</p>  <p>(A & M) (Drain) 2", 3", 4" (A & M) (Non-Drain) 3", 4", 8", 10"</p>	<p>McDOWELL TYPE</p>  <p>(Drain) 3", 4" (Non-Drain) 3", 4", 6"</p>	<p>RAINWAY, ROUND TYPE</p>  <p>3"</p>	<p>STOUT TYPE</p>  <p>2", 4"</p>	<p>RUBBER COUPLINGS</p>  <p>6"x6", 8"x8", 10"x10", 12"x12"</p>
<p>CLOUDBURST TYPE</p>  <p>6"</p>	<p>PIERCETYPE</p>  <p>(Drain) (Ames OCL, Old Style, A&M, Atlas, Deotto and Rainway) 3"</p>	<p>RAINWAY SQUARE</p>  <p>(Travis Type) 2", 8"</p>	<p>"C" SHAPED TYPE</p>  <p>(Fits #77, 78, 75 Coupling) Neoprene. (For oil specify "Buara-N") 2", 2-1/2", 3", 4", 5", 6", 8", 10", 12"</p>	<p>VALVE DISC, 4" CONED</p>  <p>Rubber Covered One Side 1-127, 128-511, 512 or more 3-78" Rubber Covered Both Sides 1-127</p>
<p>DIAMOND PLASTIC TYPE</p>  <p>PGP Vulcan Gasket (Watergate) 10", 12"</p>	<p>(Non-Drain) 2", 3", 4", 5", 6", 8", 10", 11, 550, 12"</p>  <p>Wheel Line 4-1/2" ID x 250 Orad Seal</p>	<p>RAVITTYE</p>  <p>3"</p>	<p>WADE TYPE</p>  <p>(Very Slow Drain) WR for Handing, Mainline & Solidbet 2", 3", 4", 5", 6"</p>	<p>VALVE OPEING CHEVRON</p>  <p>58" Alumax - A&M and Felton Type</p>
<p>FARMLAND TYPE</p>  <p>SBS-O Type (Drain) 2", 3", 4", 5", 6"</p>	<p>PORT-ALUM TYPE</p>  <p>2", 3", 4"</p>	<p>REDI-RAIN TYPE</p>  <p>(Non-Drain) 2", 3", 4", 5", 6", 8", 12"</p>	<p>Power8 Type 4", 4-1/2", 5"</p> 	<p>WESTERN TYPE</p>  <p>(Non-Drain) Ireco Old Style (A&M, T&L, Band & Hook, Steelume Pierce Flat Back) 2", 3", 4", 5", 6", 8", 10" - Wide (Both lips, same height)</p>
<p>SBS-ORO Type (Green Dot) (Non-Drain) 2", 3", 4", 5", 8"</p> 	<p>PROTEKTYPE</p>  <p>Diaphragm Series 900 Type Diaphragm No. 7 Type (Bentley 60)</p>	<p>Valve Disc, 4"</p>  <p>Flat-Rubber Only, 3"</p>	<p>O Ring Wheel Line 4-3/4" ID x 3/16"</p> 	<p>3/4" Ames, Alumax, Bush 110g, Ireco Pierce, Shure-Rate and Western Type</p> 
<p>FELTON TYPE</p>  <p>(Non-Drain) (Kroy) 4", 5", 8"</p> <p>Valve Disc 4" (Also fits Ames & Redi-Rain Rubber Covered Both Sides 1-127, 128-511, 512 or more)</p> 	<p>Diaphragm No. 700P Type</p>  <p>Diaphragm No. 90 Type Discharge Valve - #910 Suction Valve - #914</p> 	<p>Mine-Drain Plug</p>  <p>Valve Opening Chevron</p> 	<p>WYSS TYPE</p>  <p>2"</p>	<p>WADE TYPE</p>  <p>3/4" x 1/8"</p>



PARTS

STEEL REPAIR SLEEVE GALVANIZED



SRS

Lake/Univ. Crown Roundback	PN#	Description	Weight
	716225	3"	1.90 lbs.
	716226	4"	2.40 lbs.
	716227	5"	4.35 lbs.
	716228	6"	5.45 lbs.
	716229	8"	10.45 lbs.
	716230	10"	14.10 lbs.
	716231	12"	15.60 lbs.

SRS Repair Sleeve Galvanized Steel

STEEL RINGLOCK SURGE END PLUG

(Male Ringlock x Surge End Plug)



SRSEP

Lake/Univ. Crown Roundback	PN#	Description	Weight
	716992	4"	5.00 lbs.
	716993	6"	8.50 lbs.
	716994	8"	10.00 lbs.
	716995	10"	18.00 lbs.
	716996	12"	23.00 lbs.

SRSEP Surge End Plug Ringlock Steel

STEEL THREADED PRESSURE RELIEF VALVE



SWPR

Lake/Univ. Crown Roundback	PN#	Description	Weight
	716999	4"	4.00 lbs.

SWPR Pressure Relief Valve Weld-on



**ROAD GUARD/
SNAP-ON**

(Fits 3/4" or 1" Risers)



RG

Lake/Univ. Crown	Roundback	PN#	Description	Weight
		711897	Solid	1.40 lbs.
		711503	Screen	1.40 lbs.

RG Road Guard, Snap-On

**LATERAL PIPE
CARRIER**



LPC

Lake/Univ. Crown	Roundback	PN#	Description	Weight
		710958	3"	2.15 lbs.
		710960	4"	2.15 lbs.

LPC Lateral Pipe Carrier

**SWAGED
GALVANIZED
PIPE RISERS**

(3/4" Male Thread x 1/2" Female Thread)



Lake/Univ. Crown	Roundback	PN#	Description	Weight
		710352	12"	1.10 lbs.
		710353	18"	1.60 lbs.
		710354	24"	2.30 lbs.
		710355	30"	2.90 lbs.
		710356	36"	3.50 lbs.

Swaged Galvanized Pipe Risers

**COUPLED
GALVANIZED
PIPE RISERS**

(3/4" Male Thread x 3/4" Female Thread)



Lake/Univ. Crown	Roundback	PN#	Description	Weight
		710362	12"	1.10 lbs.
		710363	18"	1.60 lbs.
		710364	24"	2.30 lbs.
		710365	30"	2.90 lbs.
		710366	36"	3.50 lbs.

Coupled Galvanized Pipe Risers



LAKE COMPANY

Portable Aluminum Water Loading Stand

This portable loading stand is fabricated from heavy aluminum tubing. The entire stand can be easily transported on a pickup truck and quickly assembled by one man. In use, the large base fills with water, giving the unit great stability.

STANDARD DIMENSIONS:

BASE- six feet square

HEIGHT- twelve feet to bottom of spout

OUTLET SPOUT- seven feet from riser



4" Water Loading Stand # 710834 - 80 Lbs.

6" Water Loading Stand # 710836 - 125 Lbs.

8" Water Loading Stand # 710838 - 165 Lbs.



HYDRANTS

"QUICK SEAL" HYDRANT

Single or Double Outlets Available



USE

The Waterman "Quick Seal" hydrant is ideal for adapting valves installed inside concrete risers for use with gated pipe. It can also be used to provide directional flow from a valve riser.

FEATURES

- Light weight roll-formed aluminum body
- Corrosion resistant
- Quick acting stirrup clamps expand neoprene gasket inside riser for tight sealing
- Heads to 20 feet• Choice of standard quick coupler, or straight outlets - single or double
- Standard dimensions or customized to suit your needs.

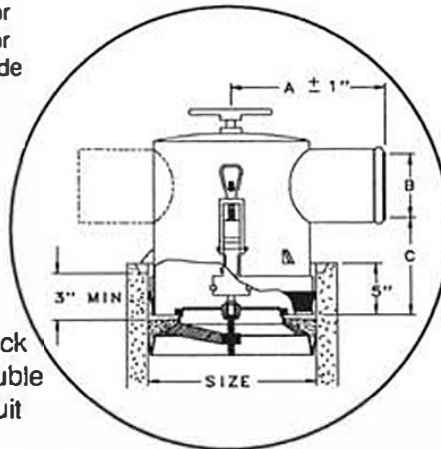

Size	10"			12"				14"				16"			
A	11 5/8			12 5/8				13 5/8				14 5/8			
B	4	6	8	4	6	8	10	4	6	8	10	4	6	8	10
C	11 1/4	9 1/4	7 1/4	11 1/4	9 1/4	7 1/4	5 1/4	11 1/4	9 1/4	7 1/4	5 1/4	11 1/4	9 1/4	7 1/4	5 1/4

SLIP-SEAL HYDRANT

This unit is custom built from roll-formed aluminum sheet featuring an abrasion-resistant rubber gasket. When ordering specify O.D. of concrete riser, height of body (H), type (quick coupler or straight), size (B) and height (C) of outlets. Center gates or "octopus gate" type installations can also be shipped.



Bottom View

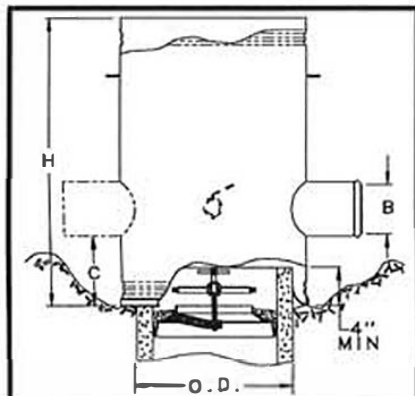

Lightweight Formed and Welded Aluminum Construction



FLOOD IRRIGATION

Siphon Tubes

SINGLE BEND-Plastic



SIZES

3/4" x 60"	1 1/2" x 60"
3/4" x 72"	1 1/2" x 72"
	1 1/2" x 90"
1" x 60"	2" x 60"
1" x 72"	2" x 72"
1" x 90"	2" x 90"
	3" x 66"
1 1/4" x 60"	
1 1/4" x 72"	
1 1/4" x 90"	

DOUBLE BEND-Plastic



SIZES

3/4" x 54"	1 1/2" x 54"
3/4" x 60"	1 1/2" x 60"
3/4" x 72"	1 1/2" x 72"
1" x 54"	2" x 54"
1" x 60"	2" x 60"
1" x 72"	2" x 72"
1 1/4" x 54"	3" x 72"
1 1/4" x 60"	
1 1/4" x 72"	

TRIPLE BEND-Plastic



SIZES

1" x 90"
1 1/4" x 90"
1 1/2" x 90"
2" x 90"
3" x 90"

SINGLE BEND-Aluminum



SIZES

3/4" x 60"	1 1/2" x 60"
1" x 60"	2" x 60"
	3" x 60"
1 1/4" x 60"	

DOUBLE BEND-Aluminum



SIZES

3/4" x 54"	2" x 54"
3/4" x 60"	2" x 60"
3/4" x 72"	2" x 72"
1" x 54"	3" x 66"
1" x 60"	3" x 72"
1" x 72"	
1 1/4" x 54"	4" x 72"
1 1/4" x 60"	4" x 96"
1 1/4" x 72"	5" x 96"
1 1/2" x 54"	6" x 96"
1 1/2" x 60"	
1 1/2" x 72"	

TRIPLE BEND-Aluminum



SIZES

1" x 90"	5" x 96"
	5" x 120"
1 1/4" x 90"	
	6" x 96"
1 1/2" x 90"	
	6" x 120"
2" x 90"	
3" x 90"	
3" x 120"	
4" x 96"	
4" x 120"	

PLASTIC REDUCERS



SIZES

1 1/4" to 1"
1 1/2" to 1"
2" to 1"
2" to 1 1/2"

ACCESSORIES

"Rubber stoppers for 6" O.D. siphon tubes."

Row Tubes

Plastic

1 1/4", 1 1/2", 2", 3"

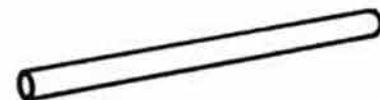

4", 5" & 6" O.D. siphon tubes are equipped with handles.



FLOOD IRRIGATION

Alfa Valves

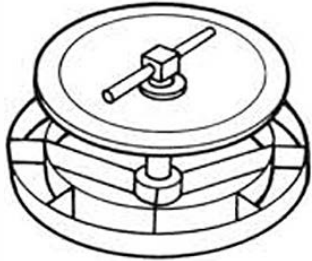

Air Vents and Vacuum Relief



AVP-1

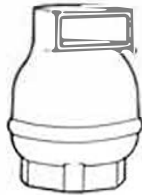

AV150
AV200
High Head

Pressure Relief

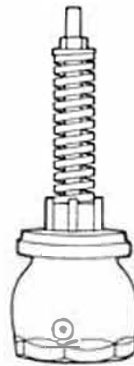

AA6

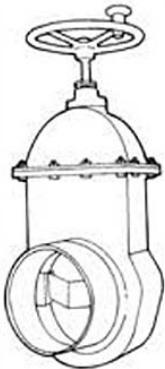

Line Gate



Canal Gates

CL-10

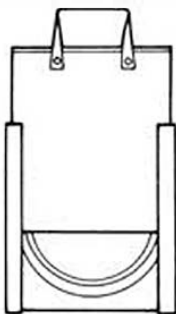

Distributing Gate

C-2

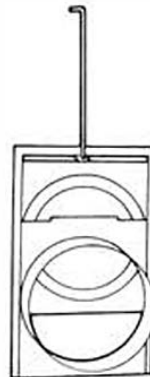

Slide Ditch Gate

C-8



GROOVED & SMOOTH-END FLOWMETER MODEL MG100 / MS 100

DESCRIPTION

Model MG100 and MS100 meters are designed to provide high pressure rating and "Main Line" meter accuracy in an inexpensive package. The flowmeters are manufactured to comply with the applicable provisions of the American Water Works Association Standard No. C704-92 for propeller type flowmeters. The impeller and drive assembly are fully accessible through the open end of the meter tube.

Impellers are manufactured of high-impact plastic, capable of retaining their shape and accuracy over the life of the meter. Each impeller is individually calibrated at the factory to accommodate the use of any standard McCrometer register, and since no change gears are used, the flowmeters can be field-serviced without the need for factory recalibration. Factory lubricated, stainless steel bearings are used to support the impeller shaft. The shielded bearing design limits the entry of materials and fluids into the bearing chamber providing maximum bearing protection.

An instantaneous flowrate indicator is standard and available in gallons per minute, cubic feet per second, liters per second and other units. The register is driven by a flexible steel cable encased within a protective vinyl liner. The register housing protects both the register and cable drive system from moisture while allowing clear reading of the flowrate indicator and totalizer.

INSTALLATION

Standard installation is horizontal mount. If the meter is to be mounted in the vertical position, please advise the factory. A straight run of full pipe the length of five diameters ahead and one diameter behind the meter is the minimum normally recommended.

APPLICATIONS

The McCrometer propeller meter is the most widely used flowmeter for municipal and wastewater treatment applications as well as agricultural and turf irrigation measurement. Typical applications include:

- Center pivot systems
- Sprinkler irrigation systems
- Drip irrigation systems
- Golf course and park water management
- Gravity turnouts from underground pipelines
- Commercial nurseries
- Water and Wastewater management

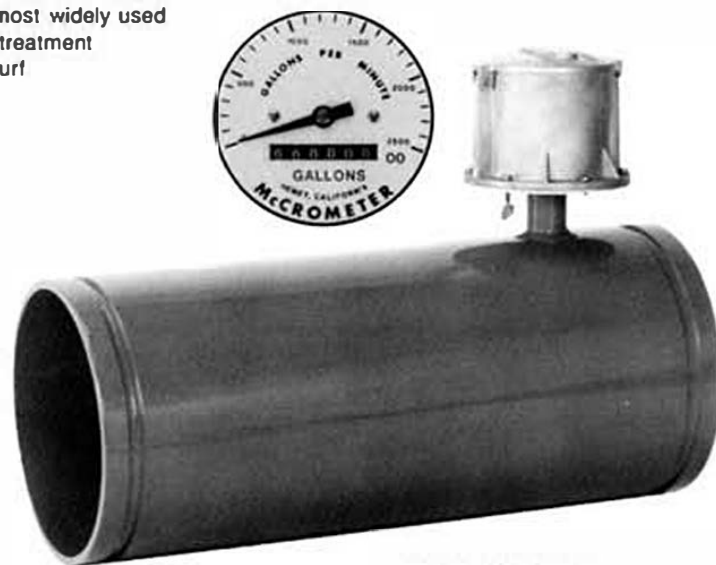

SHOWN: MODEL MG100

McCrometer Copyright



FLOW METERS

KETEMA INC.
McCROMETER Division
 FILE: SALES\FXDELMAN

DESC 4" THRU 24" FIXED ELL METERS
 DATE 09-24-93 BY CEM APP

MF100, MG100, MS100, MT104, MT106

NOTES:
 1. XX DEPENDS ON SPECIFIC REQUIREMENT

SIZE	REGISTER	PROPELLER	BEARING	(20)	(14)	(18)
	(6)	(21)		CABLE	LINE	
4"	R1104-XX	P0104-XX	B0600-XX	D0104-00	10'	
6"	R1106-XX	P0106-XX	B0100-XX	D0104-00	10'	
8"	R1108-XX	P0108-XX	B0100-XX	D0104-00	10'	
10"	R1110-XX	P0110-XX	B0100-XX	D0122-00	12'	
12"	R1112-XX	P0112-XX	B0100-XX	D0105-00	12'	
14"	R1114-XX	P0112-XX	B0100-XX	D0123-00	13'	
16"	R1116-XX	P0112-XX	B0100-XX	D0123-00	13'	
18"	R1118-XX	P0116-XX	B1500-XX	18.19'	16'	
20"	R1120-XX	P0116-XX	B1500-XX	18.19'	16'	
24"	R1124-XX	P0116-XX	B1500-XX	20.187'	18'	

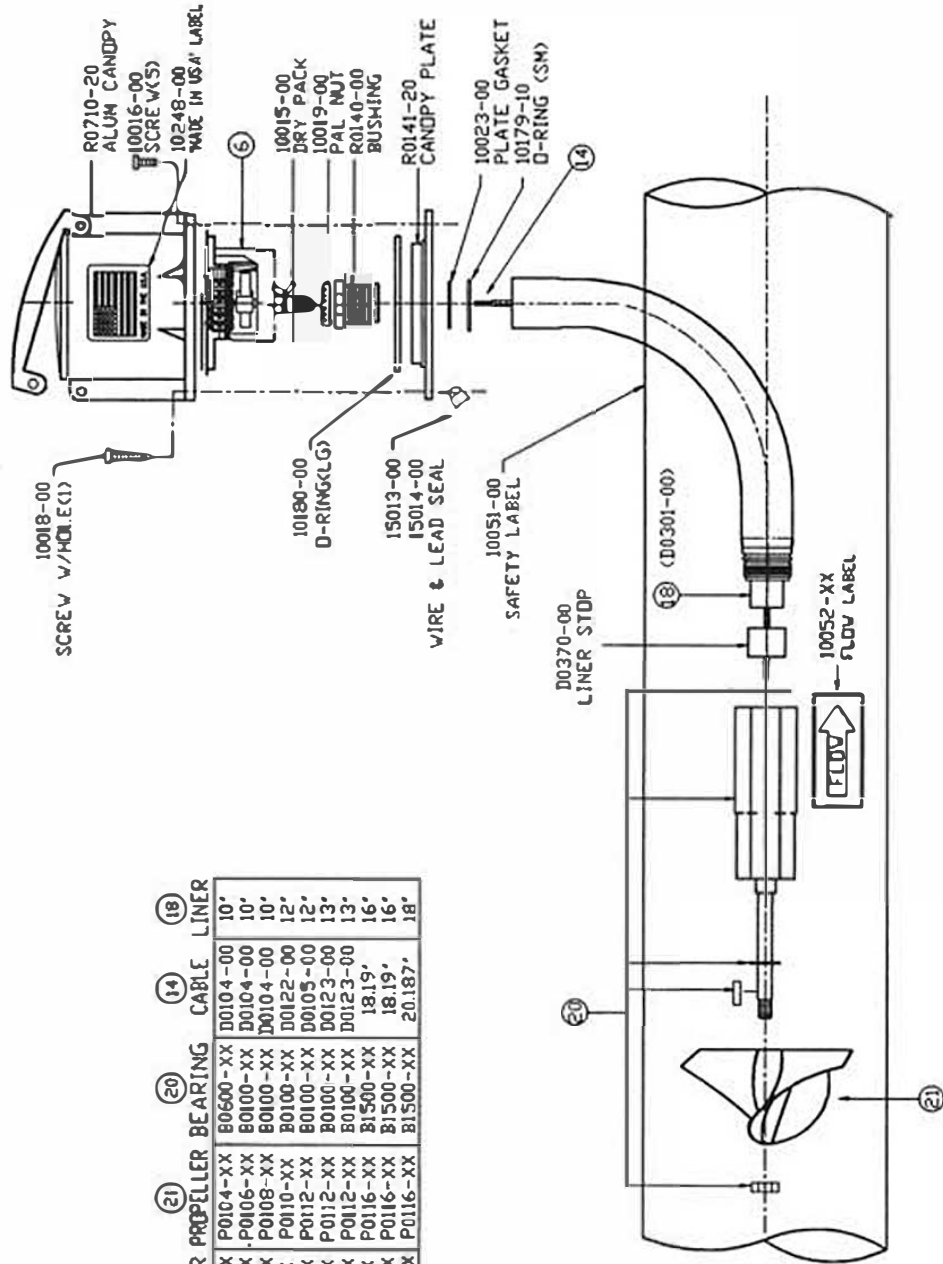

Data From McCrometer



FLOW METERS

GROOVED-END MODEL MG100 / MS100

SPECIFICATIONS

PERFORMANCE

ACCURACY/REPEATABILITY: $\pm 2\%$ of reading guaranteed throughout full range. $\pm 1\%$ over reduced range. Repeatability 0.25% or better.

RANGE: (see dimensions chart below).

HEAD LOSS: (see dimensions chart below).

MAXIMUM TEMPERATURE: (Standard Construction)
160°F constant

PRESSURE RATING: 150 psi.

MATERIALS

TUBE: epoxy-coated carbon steel.

BEARING ASSEMBLY: Impeller shaft is 316 stainless steel. Ball bearings are 440C stainless steel.

MAGNETS: Permanent type. Cast or sintered alnico.

BEARING HOUSING: Brass; stainless steel optional.

IMPELLER: Impellers are manufactured of high-impact plastic, retaining their shape and accuracy over the life of the meter. High temperature impeller is optional.

REGISTER: An instantaneous flowrate indicator and six-digit straight-reading totalizer are standard. The register is hermetically sealed within a die cast aluminum case. This protective housing includes a domed acrylic lens and hinged lens cover with locking hasp.

COATING: Fusion-bonded epoxy.

OPTIONS

- Forward/reverse flow measurement
- High temperature construction
- "Over Run" bearing assembly for higher-than-normal flowrates
- Electronic Propeller Meter available in all sizes of this model
- A complete line of flow recording/control instrumentation
- Straightening vanes and register extensions available
- Certified calibration test results

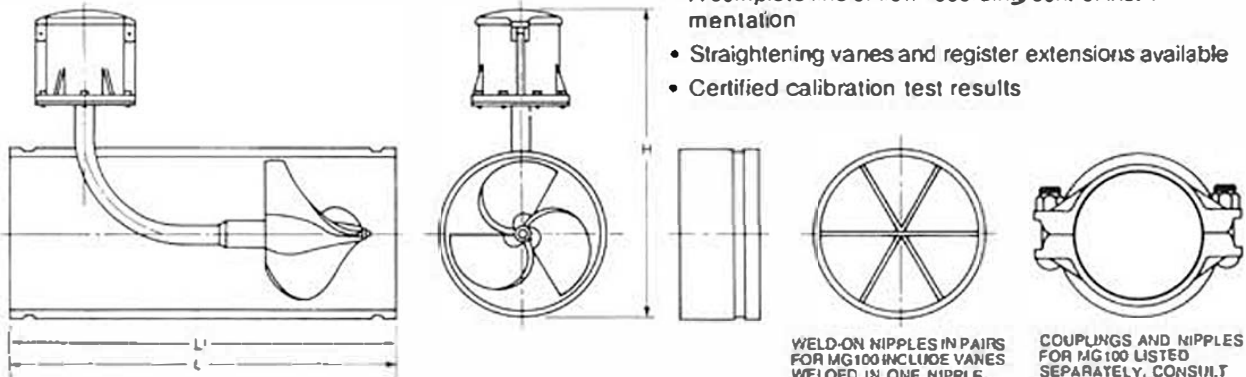

McCROMETER reserves the right to change design or specifications without notice.

WELD-ON NIPPLES IN PAIRS FOR MG100 INCLUDE VANES WELOED IN ONE NIPPLE.

COUPLINGS AND NIPPLES FOR MG100 LISTED SEPARATELY. CONSULT FACTORY FOR PRICE.

MG100 / MS100		DIMENSIONS											
Meter Size (Inches)	2	2½	3	4	6	8	10	12	14	16	18	20	24
Maximum Flow U.S. GPM			250	600	1200	1500	1800	2500	3000	4000	5000	6000	8500
Minimum Flow U.S. GPM			35	50	90	100	125	150	250	275	400	475	700
Head Loss in inches at Max. Flow			29.50	23.00	17.00	6.75	3.75	2.75	2.00	1.75	1.50	1.25	1.00
Shipping Weight, lbs.			17	40	54	68	87	106	140	144	172	181	223
H (inches)			10	12.625	13.687	14.687	16.75	18.75	20.375	22.375	25.375	26.375	30.375
L (inches) MG100			13	20	20	20	20	20	20	22	22	22	22
L' (inches) MS100			13	20	22	22	22	22	22	24	24	24	24
O.D. of Meter Tube			3.50	4.500	6.625	8.625	10.750	12.750	14.00	16.00	18.00	20.00	24.00

*Special Note -- Reducing fittings incorporating vanes are available to adapt the 3-inch model to smaller line sizes. Minimum flow for 3-inch pipe still applies.

Larger flowmeters on special order



GATES

TECHNICAL DATA FLOW CAPACITIES AT GIVEN GATE SETTINGS

FCR GATE



HEAD ON FCR GATE			FCR GATE SETTING					
PSI	FEET	INCHES	1/16	1/8	1/4	1/2	3/4	FULL
0.108	0.25	3	1.0 GPM	2.5 GPM	6.3 GPM	13 GPM	20 GPM	27 GPM
0.271	0.50	6	1.4 GPM	3.6 GPM	9.0 GPM	19 GPM	29 GPM	39 GPM
0.434	1.00	12	2.0 GPM	5.1 GPM	13 GPM	27 GPM	41 GPM	60 GPM
0.650	1.50	18	2.5 GPM	6.3 GPM	16 GPM	34 GPM	51 GPM	69 GPM
0.857	2.00	24	2.8 GPM	7.3 GPM	18 GPM	39 GPM	58 GPM	80 GPM
1.084	2.50	30	3.2 GPM	8.2 GPM	21 GPM	44 GPM	66 GPM	90 GPM
1.301	3.00	36	3.5 GPM	9.1 GPM	23 GPM	48 GPM	71 GPM	98 GPM
1.734	4.00	48	4.1 GPM	10.5 GPM	26 GPM	55 GPM	82 GPM	111 GPM

RITE-FLOW GATE



HEAD ON RITE FLOW GATE			SMALL RITE-FLOW GATE SETTING			LARGE RITE FLOW GATE SETTING		
PSI	FEET	INCHES	1 TURN OPEN	2 TURN OPEN	3 TURN OPEN	1 TURN OPEN	2 TURN OPEN	3 TURN OPEN
0.434	1	12	7	14	22	18	40	55
0.867	2	24	12	21	32	22	49	70
1.301	3	36	16	27	39	26	57	82
1.736	4	48	19	32	45	29	64	94
2.170	5	60	22	36	50	32	70	103
2.604	6	72	25	40	54	35	75	110
4.340	10	120	FULL	OPEN	70	FULL	OPEN	150

ROUTED HOLE SIZE 2 3/8"

ROUTED HOLE SIZE 3 1/8"



SPRINKLERS

We handle a complete line of sprinklers and sprinkler parts. Not all items are stocked in all stores.

RAIN BIRD®



MODEL
14 JH
20 JH
29 JH
30 WSH

Big Gun

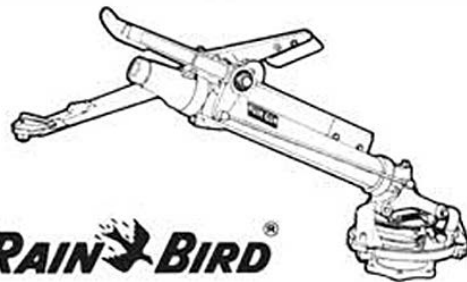

RAIN BIRD®



Nelson



MODEL
F32S

Big Gun

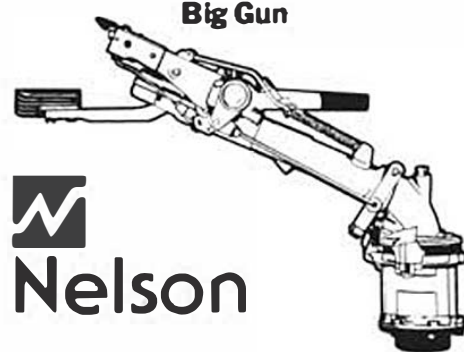

Nelson



MODEL
10-16
10-20
26 SS
10-30



TORO AG 1





PRESSURE LOSS THROUGH WATER METERS

Pressure Loss Through Water Meters

Flow GPM	5/8"	3/4"	1"	1 1/2"	2"	3"	4"
1	0.2	0.1					
2	0.3	0.2					
3	0.4	0.3					
4	0.6	0.5	0.1				
5	0.9	0.6	0.2				
6	1.3	0.7	0.3				
7	1.8	0.8	0.4				
8	2.3	1.0	0.5				
9	3.0	1.3	0.6				
10	3.7	1.6	0.7				
11	4.4	1.9	0.8				
12	5.1	2.2	0.9				
13	6.1	2.6	1.0				
14	7.2	3.1	1.1				
15	8.3	3.8	1.2				
16	9.4	4.1	1.4	0.4			
17	10.7	4.6	1.6	0.5			
18	12.0	5.2	1.8	0.6			
19	13.4	5.8	2.0	0.7			
20	15.0	6.5	2.2	0.8			
22		7.9	2.8	1.0			
24		9.5	3.4	1.2			
26		11.2	4.0	1.4			
28		13.0	4.6	1.6			
30		15.0	5.3	1.8			
32			6.0	2.1	0.8		
34			6.9	2.4	0.9		
36			7.8	2.7	1.0		
38			8.7	3.0	1.2		
40			9.6	3.3	1.3		
42			10.6	3.8	1.4		
44			11.7	3.9	1.5		
46			12.8	4.2	1.6		
48			13.9	4.5	1.7		
50			15.0	4.9	1.9	0.7	
52				5.3	2.1		
54				5.7	2.2		
56				6.2	2.3		
58				6.7	2.5		
60				7.2	2.7		
65				8.3	3.2	1.1	
70				9.8	3.7	1.3	
75				11.2	4.3	1.5	
80				2.8	4.9	1.6	0.7
90				16.1	6.2	2.0	0.8
100				20.0	7.8	2.5	0.9
110					9.5	2.9	1.0
120					11.3	3.4	1.2
130					13.0	3.9	1.4
140					15.1	4.5	1.6
150					17.3	5.1	1.8
160					20.0	5.8	2.1
170						6.5	2.4
180						7.2	2.7
190						8.0	3.0
200						9.0	3.2
220						11.0	3.9
240						13.0	4.7
260						15.0	5.5
280						17.3	6.3
300						20.0	7.2
350							10.0
400							13.0
450							16.2
500							20.0

Information contained in this manual is based upon generally accepted formulas, computations, and trade practices. Rain Bird Sprinkler Mfg. Corp. and its subsidiaries and affiliates, shall not be responsible or liable therefor if any problems, difficulties, or injuries should arise from or in connection with the use or application of this information, or if there is any error herein, typographical or otherwise.

Courtesy: Rain Bird Sprinkler Mfg. Corp. • 145 N. Grand Avenue, Glendora, CA 91741-2469 • (626) 963-9311 webmaster@rainbird.com



GENERAL INFORMATION

WATER

One miner's inch = 1½ cubic feet per minute = 11.25 U.S. gallons per minute = flow per minute through 1 inch square opening in 2 inch thick plank under a head of 6½ inches to centre of orifice in Arizona, California, Montana, Nevada and Oregon. 9 U.S. gallons per minute in Idaho, Kansas, Nebraska, N.M., N.D., S.D., Utah.

One horse-power = 33,000 ft. pounds per minute.

Cubic feet per second = $\frac{\text{Gallons per minute}}{4.49}$

Cubic feet per minute = $\frac{\text{Gallons per minute}}{7.48}$

Theoretical water horse-power = $\frac{\text{U.S.G.P.M.} \times \text{head in feet} \times \text{Sp. Gr.}}{3960}$

Theoretical water horse-power = $\frac{\text{U.S. gallons per minute} \times \text{head in pounds}}{1714}$

Brake horse-power = $\frac{\text{Theoretical water horse-power}}{\text{Pump efficiency}}$

Velocity in feet per second = $\frac{408 \times \text{U.S. gallons per min.}}{(\text{Diameter of pipe in inches})^2 \times \text{pipe area}} = \frac{32 \times \text{G.P.M.}}{\text{pipe area}}$

One acre-foot = 325,850 U.S. gallons.

1,000,000 U.S. gallons per day = 665 U.S. gallons per minute.

500 pounds per hour = 1 U.S. gallon per minute.

Doubling the diameter of a pipe or cylinder increases its capacity four times.

Friction of liquids in pipes increases as the square of the velocity.

Velocity in feet per minute necessary to discharge a given volume of water,

in a given time = $\frac{\text{Cu. Ft. of water} \times 144}{\text{area of pipe in sq. inches}}$

Area of required pipe, the volume and velocity of water

being given = $\frac{\text{No. cu. ft. water} \times 144}{\text{Vel. in ft. per min.}}$

from this area the size pipe required may be selected from the table of standard pipe dimensions.

Atmospheric pressure at sea level is 14.7 pounds per square inch. This pressure with a perfect vacuum will maintain a column of mercury 29.9 inches or a column of water 33.9 feet high. This is the theoretical distance that water may be drawn by suction. In practice, however, pumps should not have a total dynamic suction lift greater than 25 feet.

Net horse-power = the theoretical horse-power necessary to do the work.

Net horse-power = barrels per day x pressure x .00017.

Net horse-power = barrels per hour x pressure x .000408.

Net horse-power = gallons per minute x pressure x .000583

The customary method of indicating specific gravity of petroleum oils in this country is by means of the Baume scale. Since the Baume scale, for specific gravities of liquids lighter than water, increases inversely as the true gravity, the heaviest oil, i.e., that which has the highest true specific gravity, is expressed by the lowest figure of the Baume scale; the lightest by the highest figure.

MISCELLANEOUS

Areas of circles are to each other as the squares of their diameter.

Circumference-diameter of circle x 3.1416.

Area circle-diameter squared x .7854.

Diameter circle-circumference x .31831.

Volume of sphere-cube of diameter x .5236.

Square feet-square inches x .00695.

Cubic feet-cubic inches x .00058.

Cubic yard-cubic feet x .03704.

Statute miles-lineal feet x .00019.

Statute miles-lineal yards x .000568.

1 gallon = 8.33 pounds.

1 liter = .2642 gallons.

1 cu. ft. = 7.48 gallons and/or 62.35 pounds.

1 meter = 3.28 feet.

1 millimeter = .03937 inches.

STATIC HEAD

Static Head is the vertical distance between the free level of the source of supply and the point of free discharge, or to the level of the free surface of the discharged water.

TOTAL DYNAMIC HEAD

TOTAL DYNAMIC HEAD is the vertical distance between source of supply and point of discharge when pumping at required capacity, plus Velocity Head, friction, velocity, entrance and exit losses.

TOTAL DYNAMIC HEAD, as determined on test where Suction Lift exists, is the reading of a mercury column connected to the suction nozzle of pump, plus the reading of a pressure gauge connected to discharge nozzle of pump, plus vertical distance between point of attachment of mercury column and centre of gauge, plus excess, if any, of Velocity Head of discharge over Velocity Head of suction, as measured at points where the instruments are attached, plus head of water resting on mercury column, if any.



HOW TO IDENTIFY FITTINGS & GASKETS

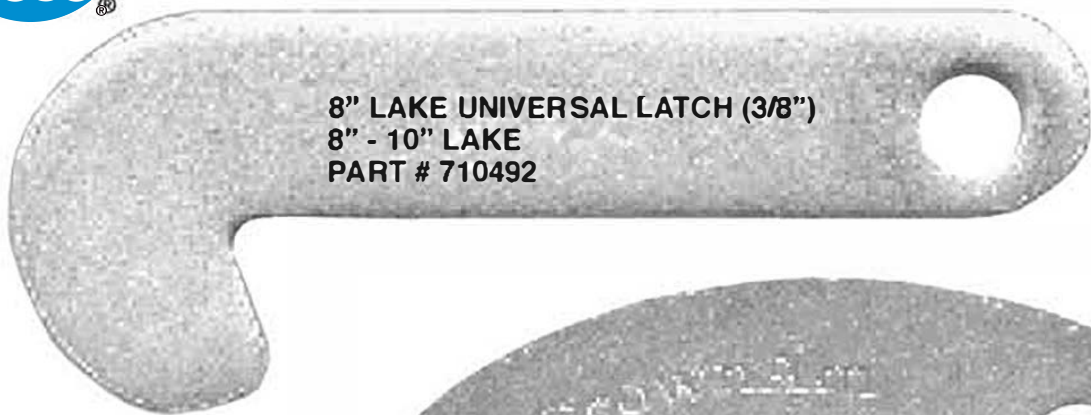

**8" LAKE UNIVERSAL LATCH (3/8")
8" - 10" LAKE
PART # 710492**



**CROWN LATCH (1/4")
2" - 6" FOR CROWN FITTINGS
PART #717491**

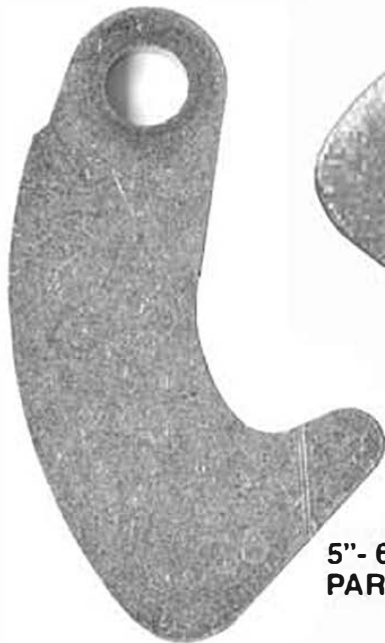

**SMALL LATCH (1/4")
VOE SHORT LATCH
PART #710476**



**2" - 6" LAKE UNIVERSAL LATCH (1/4") GOLD
2" - 4" LAKE
PART # 710490**

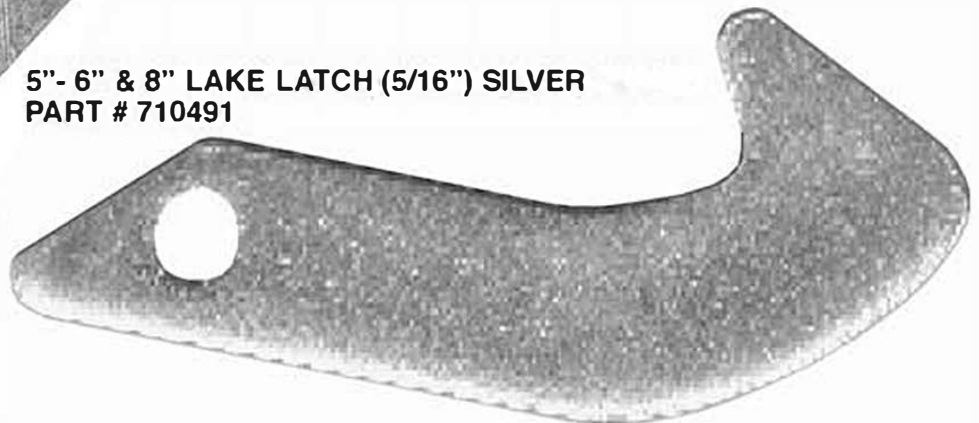

**5" - 6" & 8" LAKE LATCH (5/16") SILVER
PART # 710491**



THE ORIGINAL IRRIGATION MANUFACTURER AND WHOLESALER

As a single source wholesale distributor for irrigation parts and systems, Lake Company provides high quality pipe, valves, fittings, wheel moves and pumps to satisfy the needs of the irrigation industry.

Founded in 1977, Lake Company is headquartered in Bakersfield, CA, where we strive to deliver exceptional equipment and first rate service. Each of us at Lake Company take a personal investment in providing you service, from first contact to delivery.

As a pipe manufacturer, we understand the need for quality and durable products. We stand behind our pipe and fittings, and proudly see them still used in fields decades after they were originally manufactured at our California tube mill and foundry locations.

Our quality control ensures that you receive the superior product. Each joint of pipe we manufacture is hydrostatically tested to withstand more than 200 PSI during the manufacturing process. This means you get pipe that will not leak and that is backed up by our warranty.



Quality Products. Made Right. Made in America.

800-821-7273
lakecompany.com



“The Original Irrigation Manufacturer”



800-821-7273
lakecompany.com